

GAMRY INSTRUMENTS

Reference 600+™

Potentiostat/Galvanostat/ZRA

Operator's Manual



Copyright © 2018 Gamry Instruments, Inc.
Revision 6.21
June 12, 2018
988-00006

If You Have Problems

Please visit our service and support page at www.gamry.com/service-support/. This page contains information on installation, software updates, and training. It also contains links to the latest available documentation. If you are unable to locate the information you need from our website, contact us via email using the link provided on our website. Alternatively, you can contact us one of the following ways:

Internet	www.gamry.com/service-support/
Telephone	(215) 682-9330 9:00 AM–5:00 PM US Eastern Standard Time (877) 367-4267 Toll Free US & Canada Only

Please have your instrument model and serial numbers available, as well as any applicable software and firmware revisions.

If you have problems in installation or use of a system containing a Reference 600+, please try to call from a telephone next to your computer, where you can type and read the screen while talking to us.

We will be happy to provide a reasonable level of free support for registered users of the Reference 600+ Potentiostat/Galvanostat/ZRA. Reasonable support includes telephone assistance covering the normal installation, use, and simple customization of a computerized system containing a Reference 600+ connected to a Windows®-compatible computer.

A service contract that extends both the hardware warranty and software update period is available at an additional charge. Software updates **do not** include software enhancements offered to our customers at additional cost.

Enhancements to the Reference 600+ and Gamry's standard applications software that require significant engineering time on our part can be performed on a contract basis. Contact us with your requirements.

Limited Warranty

Gamry Instruments, Inc. warrants to the original user of this product that it shall be free of defects resulting from faulty manufacture of the product or its components for a period of two years from the original shipment date of your purchase.

Gamry Instruments, Inc. makes no warranties regarding either the satisfactory performance of the Reference 600+ Potentiostat/Galvanostat/ZRA including the software provided with this product or the fitness of the product for any particular purpose. The remedy for breach of this Limited Warranty shall be limited solely to repair or replacement, as determined by Gamry Instruments, Inc., and shall not include other damages.

Gamry Instruments, Inc. reserves the right to make revisions to the system at any time without incurring any obligation to install same on systems previously purchased. All system specifications are subject to change without notice.

There are no warranties which extend beyond the description herein. This warranty is in lieu of, and excludes any and all other warranties or representations, expressed, implied or statutory, including merchantability and fitness, as well as any and all other obligations or liabilities of Gamry Instruments, Inc., including but not limited to, special or consequential damages.

This Limited Warranty gives you specific legal rights and you may have others, which vary from state to state. Some states do not allow for the exclusion of incidental or consequential damages.

No person, firm or corporation is authorized to assume for Gamry Instruments, Inc., any additional obligation or liability not expressly provided herein except in writing duly executed by an officer of Gamry Instruments, Inc.

Disclaimers

Gamry Instruments, Inc. cannot guarantee that the Reference 600+ Potentiostat/Galvanostat/ZRA will work with all computer systems, operating systems, and third-party software applications hardware/software.

The information in this manual has been carefully checked and is believed to be accurate as of the time of printing. However, Gamry Instruments, Inc. assumes no responsibility for errors that might appear.

Copyrights

Reference 600+™ Potentiostat/Galvanostat/ZRA Operator's Manual, copyright © 2007–2018, Gamry Instruments, Inc., all rights reserved.

Gamry Framework copyright © 1989–2018, Gamry Instruments, Inc., all rights reserved.

Reference 600+™, ECM8™, Interface 1010™, Gamry Framework™, and Gamry™ are trademarks of Gamry Instruments, Inc.

Windows is a registered trademark of Microsoft Corporation. Intel is a trademark of Intel Corporation in the U.S. and/or other countries.

No part of this document may be copied or reproduced in any form without the prior written consent of Gamry Instruments, Inc.

Table of Contents

Chapter 1: Safety Considerations	3
Inspection	3
Product Safety	3
AC Mains Connection to the Power Brick	3
Grounding in the Reference 600+	4
Operation with Earth-Grounded Cells and Auxiliary Apparatus.....	5
Temperature and Ventilation	5
Defects and Abnormal Stresses	6
Environmental Limits	6
Cleaning.....	6
Service	7
RF Warning.....	7
Electrical Transient Sensitivity	7
CE Compliance	8
RoHS Compliance	8
Chapter 2: Introduction.....	9
About this Manual	9
About the Reference 600+	9
Notational Conventions.....	10
Chapter 3: Instrument Circuitry	11
Reference 600+ Schematics and Block Diagrams	11
Chapter 4: Installation	19
Initial Visual Inspection	19
Physical Location.....	20
Computer Requirements	20
Quick-start Guide for System Installation	21
Software Installation	21
Reboot your Computer after Software Installation	21
Power Cord and Power Connection.....	22
Power-up Test.....	23
USB Cables	23
Front Panel USB LED.....	24
Cell Cable Installation	24
Multiple Potentiostat Systems	25
First-time Device Installation in Windows®.....	25
Running the Framework	25
Framework Device Status Bar	25
Gamry Instrument Manager	26
Blink Button	29
Changing the Label.....	29
The Reference 600+ Customization Label.....	30
Chapter 4: Calibration	33
Introduction	33
Instrument DC and AC Calibration	33
Cable Calibration	35
Low I Range DC Calibration	37
Chapter 5: Cell Connections.....	39
Normal Cell Connections.....	39
ZRA Mode Cell Connections	40

Membrane Cell Connections	41
Chapter 6: Panel Indicators and Connectors	43
Front Panel.....	43
Rear Panel.....	46
Chapter 7: Stability in Potentiostat Mode	53
Capacitive Cells and Stability	53
Improving Potentiostat Stability.....	53
Chapter 8: Measurement of Small Signals	57
Overview	57
Measurement System Model and Physical Limitations	57
Hints for System and Cell Design	61
Floating Operation	63
Appendix A: Reference 600+ Specifications.....	65
Appendix B: Reference 600+ Cell Cable Connector	71
Appendix C: Misc. I/O Connector.....	73
Appendix D: Auxiliary A/D Input Characteristics	75
Aux A/D Specifications	75
Function Call to Set the Aux A/D BNC Characteristics	75
Appendix E: CE Certificate.....	77
Declaration of Conformity	77
Certificate of Conformance.....	79
Comprehensive Index.....	80

Chapter 1: Safety Considerations

Your Reference 600+ Potentiostat/Galvanostat/ZRA has been supplied in a safe condition. This chapter of the Reference 600+ Operator's Manual contains some information and warnings that you must follow to ensure continued safe operation of the Reference 600+.

Inspection

When you receive your Reference 600+ Potentiostat/Galvanostat/ZRA, inspect it for evidence of shipping damage. If you find any damage, please notify Gamry Instruments Inc. and the shipping carrier immediately. Save the shipping container for possible inspection by the carrier.



Warning: A Reference 600+ damaged in shipment can be a safety hazard. Do not operate damaged apparatus until a qualified service technician has verified its safety. Tag a damaged Reference 600+ to indicate that it could be a safety hazard.

Product Safety

The Reference 600+ has been designed, tested and certified to meet the requirements of EN 61010, *Safety requirements for **electrical equipment** for measurement, control, and laboratory use*. As defined in this standard, it is a Category II apparatus, with any "hazardous live voltages" protected by "reinforced insulation".

Most of the Reference 600+ circuitry operates at voltages low enough to be considered safe. The Reference 600+ contains a limited amount of internal circuitry that is at "hazardous live" voltages as defined in EN 61010 (the standard mentioned above). "Reinforced insulation" (again defined in EN 61010) is used to reduce the risk of electrical shock due to this "hazardous live" voltage.

The majority of the Reference 600+'s circuitry does not contain voltages higher than 30 V DC. As a generalization, input and output voltages in the Reference 600+ are limited to 24 V. This voltage level is considered safe.

The "AC Adapter" supplied with the Reference 600+ is certified under EN 60950. The AC Adapter converts the AC mains voltage to 24 V DC, which is used to power the Reference 600+.

Always use the AC adapter (power brick) supplied with your Reference 600+ to supply DC power to the instrument.



Caution: Do not use a DC power source other than the AC adapter model provided with your Reference 600+. Other replacements may void the performance and/or safety characteristics of the Reference 600+.

AC Mains Connection to the Power Brick

The Reference 600+ does not connect directly to an AC Mains supply. Instead, the mains are connected to desktop AC adapter (power brick), which outputs 24 V DC and in turn powers the Reference 600+.



The Reference 600+'s AC Adapter is rated for operation from 100 to 240 V AC, 47 to 63 Hz. It should therefore be useful throughout the world.

The Reference 600+ is normally provided with an AC line cord suitable for your location. This AC line cord connects the AC mains to the AC power adapter. If your Reference 600+ has been provided without an AC line cord, or a cord that is not compatible with your local AC mains socket, obtain a line cord certified for use in your country. Contact your local Gamry Representative or email to techsupport@gamry.com if you are uncertain what AC line cord to use.

Grounding in the Reference 600+

The circuitry and the metal case of the Reference 600+ are **not** connected to an earth ground. If they were connected to earth ground, it would compromise the Reference 600+'s ability to make measurements in electrochemical cells that contain earth grounded metal. A few examples of such cells include autoclaves, metallographic stress apparatus, and detectors for capillary electrophoresis.

Most electrochemical cells are isolated from earth ground, so isolation of the Reference 600+ from earth is not required. In these cases, connection of the Reference 600+ chassis to an earth ground may lower the noise seen in an electrochemical test. A Chassis Ground binding post on the rear panel of the Reference 600+ makes for easy implementation of this connection. Simply run a wire from this binding post to a suitable source of earth ground. A black 1.2-meter wire is provided with the Reference 600+ to ease this connection.



Sources of earth ground include

- Most metal water pipes,
- The chassis of **most** electronic apparatus (which are generally earth-grounded), and
- The protective ground terminal of an AC mains power plug.

We recommend that you discuss grounding with an electrical or electronics professional prior to making this earth-ground connection.

Note this connection of the Reference 600+ to an earth ground is not a "Protective Earth Ground" as defined in EN 61010. The Reference 600+ is safe in the absence of this connection.



Warning: Do not connect the chassis ground binding post to any voltage other than earth ground. An improper connection can create a safety hazard, which could result in personal injury or death.

Operation with Earth-Grounded Cells and Auxiliary Apparatus

As described above, the Reference 600+ circuitry is isolated from earth ground, allowing it to make measurements on cells that include an earth ground. This ground isolation is often called floating operation. Cells with earth ground include many autoclaves, pipelines and storage tanks, and many fuel cell systems.

Connection of the Reference 600+ to auxiliary apparatus will often earth-ground the Reference 600+ destroying its ability to float and make measurements on earth-grounded cells. Connection of the Monitor BNCs to an oscilloscope is an example where the instrument is earthed.

The User I/O connector can be connected to earth-grounded apparatus without earth-grounding the Reference 600+, if the cabling is done carefully. The metal shell on the Reference 600+ User I/O Connector is connected to the instrument's chassis which is a floating ground. In a system that needs isolation from earth ground, the shield of your I/O cable must not connect the D-connector's metal shell to earth ground. Reference all user I/O signals to pin 6 of the D-connector, which is earth ground on the Reference 600+.



Caution: Floating operation of the Reference 600+ can be compromised by improper cables to your I/O Connector. We do not recommend use of standard 15-pin shielded cables with this connector. Custom cables with the shield connected to pin 6 of the D-connector are preferred.



Warning: Do not connect the chassis ground binding post to any voltage other than earth ground. An improper connection can create a safety hazard, which could result in personal injury or death.

The Reference 600+ contains spark-gap surge suppressors that limit the voltage difference between the Reference 600+'s chassis ground and earth ground to about 90 V. These surge suppressors are not part of the safety mechanisms in the Reference 600+. Instead they are present to limit the possibility of improper instrument operation or instrument damage caused by electrostatic discharge (static electricity) and other surge events such as lightning.

Temperature and Ventilation

Your Reference 600+ Potentiostat/Galvanostat/ZRA was designed for indoor use at ambient temperatures between 0°C and 45°C.

The Reference 600+ uses forced air-cooling to keep its electronic components within their operating temperature range. Air is drawn into the Reference 600+ chassis through slots located on the sides of the chassis near the front panel. The air exits through the two fans at the rear of the unit.



Caution: Do not block the airflow into or out of the Reference 600+ chassis. While the circuitry should suffer no damage caused by excessive heat, the Reference 600+ enclosure may become uncomfortably hot to the touch if insufficient air flows through the chassis. Running the Reference 600+ without adequate cooling could shorten the time to failure of some of the circuitry.

Be careful when operating the Reference 600+ in an enclosed space (such as an enclosed relay rack or NEMA enclosure). The temperature within the enclosure must not exceed 45°C. You may need to provide ventilation holes or even forced-air cooling for the enclosed space if excessive temperature rise occurs.

Defects and Abnormal Stresses

Treat your Reference 600+ as potentially hazardous if any of the following is true of the unit:

- It shows visible damage,
- It does not operate properly,
- It has been stored for a long period of time under unfavorable conditions,
- It has been dropped or subjected to severe transport stress,
- It has been subjected to environmental stress (corrosive atmosphere, fire, etc.).

Do not use your Reference 600+ or any other apparatus if you think it could be hazardous. Have it checked by qualified service personnel.

Environmental Limits

There are environmental-limit conditions on the storage, shipping and operation of this equipment. The Reference 600+ has **not** been designed for outdoor use.

Storage

Ambient Temperature	-40°C to 75°C
Relative Humidity	Maximum 90% non-condensing

Shipping

Same as storage plus Acceleration	Maximum 30 G
--------------------------------------	--------------

Operation

Ambient Temperature	0°C to 45°C
Relative Humidity	Maximum 90% non-condensing



Warning: The Reference 600+ is not designed for operation in conditions where liquid water may enter the chassis, or water vapor may condense within the chassis. Operation of a Reference 600+ that has water within the chassis can create a safety hazard, which could result in personal injury or death.

Cleaning

Disconnect the Reference 600+ from all power sources prior to cleaning.

Use a cloth **lightly** dampened with either clean water or water containing a mild detergent, to clean the outside of the Reference 600+ enclosure. Alternatively, you may use isopropyl alcohol. Do not use a wet rag or allow fluid to enter the Reference 600+ enclosure. Do not immerse the Reference 600+ in any type of cleaning fluid (including water). Do not use any abrasive cleaners.

Service

Your Reference 600+ Potentiostat/Galvanostat/ZRA has no user-serviceable parts inside. Refer all service to a qualified service technician.



Warning: Never operate the Reference 600+ with any cover or panel on the chassis open. Dangerous voltages may be present at several points within the Reference 600+ chassis, including PC board traces. Always remove the power connection before opening the Reference 600+ case.

RF Warning

Your Reference 600+ Potentiostat/Galvanostat/ZRA generates, uses, and can radiate radio-frequency energy. The radiated levels are low enough that the Reference 600+ should not create an interference problem in most industrial laboratory environments.

The Reference 600+ has been tested for both radiated and conducted RF interference and has been found to be in compliance with FCC Part 18 and EN 61326:1998—*Electrical equipment for measurement, control, and laboratory use—EMC Requirements*.

Electrical Transient Sensitivity

Your Reference 600+ Potentiostat/Galvanostat/ZRA was designed to offer reasonable immunity from electrical transients, including transients on the incoming AC mains supply and electrostatic discharge. It has been tested for compliance with EN 61326:1998—*Electrical equipment for measurement, control, and laboratory use—EMC Requirements* describing acceptable limits for electrical transient susceptibility in laboratory test equipment. The Reference 600+ is not rated for continuous use when subject to ESD events. It should suffer no permanent damage when subject to the standard ESD events defined in EN61326, but may cease normal operation until it is powered down and restarted.

In severe cases, the Reference 600+ could malfunction as a result of electrical transients such as a static discharge. If you are having problems in this regard, the following steps may help:

If the problem is static electricity (sparks are apparent when you touch the Reference 600+ or its cables):

- Try placing your Reference 600+ on a static-control work surface. Static-control work surfaces are now generally available from computer-supply houses and electronics-tool suppliers. An antistatic floor mat may also help, particularly if a carpet is involved in generating the static electricity.
- Air ionizers or even simple air humidifiers can reduce the voltage available in static discharges.
- If the problem is AC power-line transients (often from large electrical motors near the Reference 600+):
- Try plugging your Reference 600+ into a different AC power branch circuit.
- Plug your Reference into a power-line surge-suppressor. Inexpensive surge-suppressors are now generally available because of their use with computer equipment.

Contact Gamry Instruments, Inc. if these measures do not solve the problem.

CE Compliance

The European Community has instituted standards limiting radio frequency interference emitted by electronic devices, setting limits for susceptibility of apparatus to RF energy and transient events, and mandating safety requirements. Gamry Instruments, Inc. has designed and tested the Reference 600+ to comply with these standards.

The relevant CE regulations include EN 61010 and EN 61326.

RoHS Compliance

The Reference 600+ has been built using lead-free components and lead-free solder. It is in compliance with the European RoHS initiative.

Chapter 2: Introduction

About this Manual

This manual covers the installation, safety, and use of the Gamry Instruments Reference 600+ Potentiostat/Galvanostat/ZRA.

This manual describes use of a Reference 600+ with Revision 7.0 (and later revisions) of the Gamry Framework software. It is equally useful when setting up a newly-purchased potentiostat or modifying the setup of an older potentiostat for use with new software.

Chapter 1 was an in-depth discussion of safety issues. This chapter describes this manual and gives a brief overview of the Reference 600+ features. Chapter 3 is a description of the electronic circuitry in the Reference 600+. Chapter 4 contains Reference 600+ installation instructions. Chapter 5 describes cell cable-connections and Chapter 6 describes the Reference 600+'s front and rear panels. Chapter 7 covers the difficult issues of potentiostat stability and approaches to prevent oscillation. Chapter 8 discusses the realities of low-current, high-impedance measurements.

Dry technical material such as specifications and connector pin-outs is in the Appendices.

This manual does not discuss software installation or software operation in any detail.

Software support for the Reference 600+ is described in the Gamry Framework's **Help** system.

All the Gamry Instruments' applications running under the Gamry Framework control the Reference 600+ via a PSTAT object. See the Framework **Help** system for information concerning PSTAT objects and their functions.

About the Reference 600+

The Reference 600+ Potentiostat is a research-grade electrochemical instrument packaged in a small, easy-to-handle case. It offers measurement capabilities similar to instruments that are more than ten times its size and weight and more than twice its price. The Reference 600+ can operate as a potentiostat, a galvanostat, or a ZRA (zero-resistance ammeter).

Reference 600+ features include:

- Eleven-decade current auto-ranging,
- Electrical isolation from earth ground,
- Current-interrupt *iR* compensation, and
- Both analog and digital filtering.

A sine-wave generator on the Reference 600+ allows its use for impedance measurements at frequencies up to 5 MHz. Data can be acquired at frequencies up to 300 000 points per second, allowing cyclic voltammetry at scan rates of 1500 V/s with a resolution of 5 mV per point.

A unique DSP (Digital Signal Processing) data-acquisition mode allows the Reference 600+ to reject noise from the instrument itself, from the electrochemical cell, and from the lab environment. In many cases where other instruments require a cell in a Faraday shield to make quiet measurements, the Reference 600+ can be used with the cell exposed on a bench top.

The Reference 600+ offers an unprecedented combination of high speed, high sensitivity, and low noise. At the time this is written, the Reference 600+ offers the widest EIS performance area (in a plot of impedance versus frequency) of any Potentiostat. State-of-the-art analog components were used throughout the design. In all design decisions, performance weighed more heavily than product cost.

The Reference 600+, like all Gamry potentiostats, requires a computer for its use. Unlike our older potentiostats, the Reference 600+ connects to the computer through a USB connection. The USB connection has become truly universal, with USB ports found on all modern computers. Gamry's software currently supports up to 16 Reference 600+ Potentiostats connected to one computer.

The Reference 600+ is isolated from earth ground. It can therefore be used to make measurements on cells that contain an earth-grounded metal. A few of the many examples of such systems are autoclaves, large metal storage tanks, stress apparatus, and capillary electrophoresis detectors.

Notational Conventions

In order to make this manual more readable we have adopted some notational conventions. These are used throughout this manual and all other Gamry Instruments manuals:

- Numbered lists. A numbered list is reserved for step-by-step procedures, with the steps always performed sequentially.
- Bulleted list. The items in a bulleted list, such as this one, are grouped together because they represent similar items. The order of items in the list is not critical.
- File names and folders. Inside paragraphs, references to computer files and Windows® folders are capitalized and placed within quotes, for example: "C:\MYGAMRYDATA\CV.DTA" and "GAMRY5.INI".

Chapter 3: Instrument Circuitry

Reference 600+ Schematics and Block Diagrams

If you are not familiar with electronic schematics or potentiostats, you probably want to skip this chapter. This information is for expert use only and is not required for routine use of the Reference 600+.

The following figures are partly schematic diagrams and partly block diagrams. They are intended to show the basic principles of the Reference 600+ without the confusion of the full circuitry details. The complexity of the Reference 600+ can be quite daunting: the Reference 600+ circuit boards contain more than 2500 components connected by almost 2000 circuit nets!

The schematic/block diagram figures show:

- The potentiostat board in its potentiostatic control mode,
- The control-board circuits for signal generation,
- The control-board circuits for signal conditioning and A/D conversion,
- The Auxiliary ADC channel-input switching,
- The processors in the Reference 600+, and
- DC-DC power conversion.

Figure 3-1
Reference 600+ Potentiostat Board in Potentiostat Mode
Simplified Schematic/Block Diagram

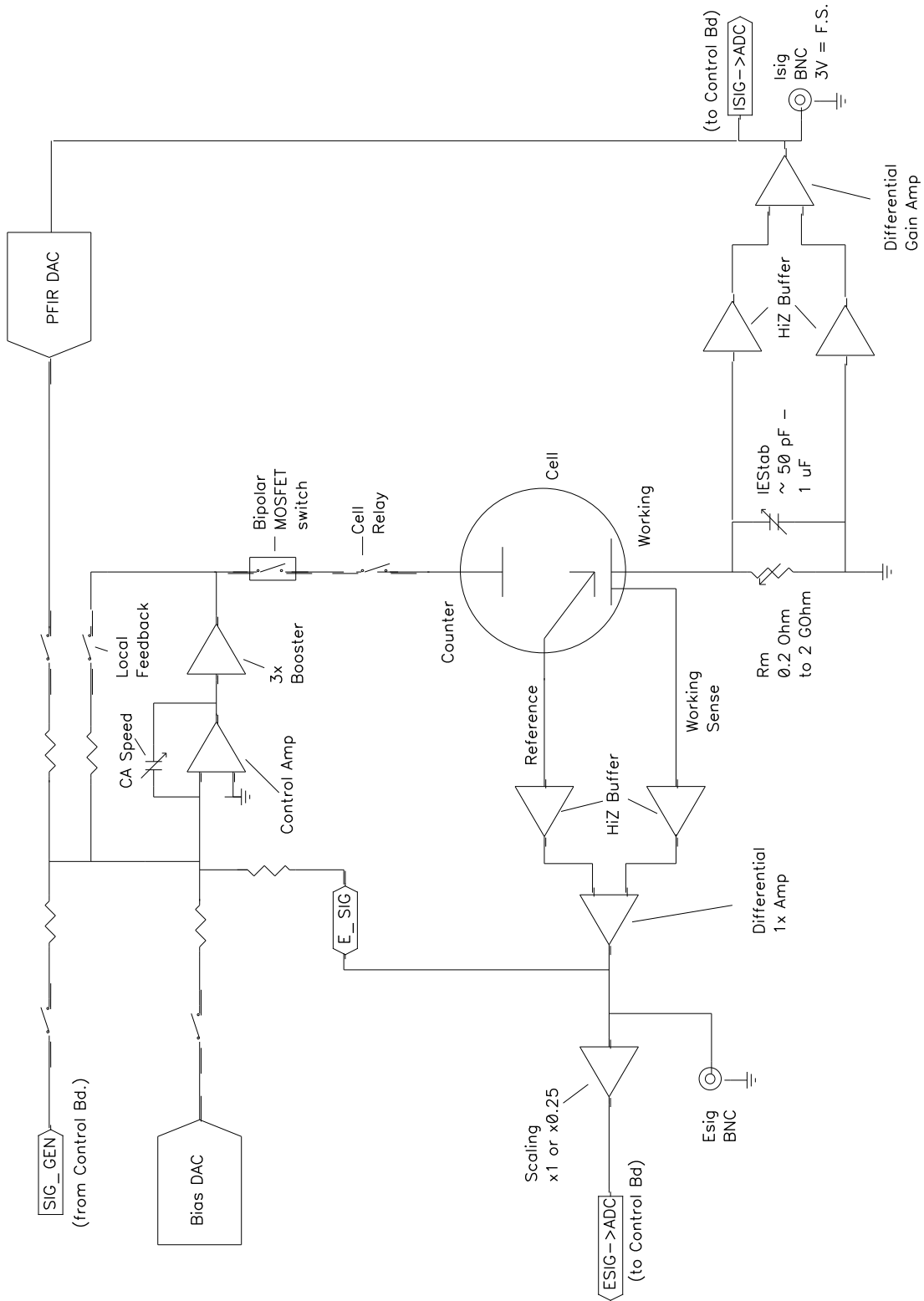

Notes for Figure 3-1

- Only Potentiostat Mode circuitry is shown in this figure. In this mode the voltage difference between the Reference and Working Sense leads (called E_{sig}) is feedback into the control amplifier.

In Galvanostat Mode, the feedback is from I_{sig} .

In ZRA mode, the feedback is from a differential amplifier measuring the difference between the Counter Sense and Working Sense leads of the cell cable. The counter sense circuitry is not shown. It is conceptually similar to the voltage-sensing circuit that generates E_{sig} .

- The Bias DAC and PFIR (Positive Feedback IR compensation) DAC are set using a computer bus that is not shown.
- Switches are either reed relays or MOS switches as appropriate. All switches are under computer control (obviously, because the Reference 600+ does not have a knob-and-dial front panel).
- All components shown as being variable (resistance R_m , capacitor I_{EStab} and capacitor $CASpeed$) are actually several fixed-value components switched into the circuit. They are not continuously variable as implied in the figure.
- The monitor BNC connectors for I_{sig} and E_{sig} are lightly filtered using an RLC circuit.
- The programmable attenuator on E_{sig} prior to the ADC channel scales E_{sig} so that it is compatible with the A/D channel's ± 3 V input range. The 0.25 gain setting allows the Reference 600+ to measure potential signals slightly in excess of 10 V (on a 12 V full-scale range). I_{sig} is gained to be 3 V full-scale so it does not require a similar attenuation function.
- All the resistors summing voltages into the Control Amplifier input do not have values shown; their values depend on scaling factors too complex to discuss in this simplified diagram.
- Calibration components are not shown.
- Gamry's software can disconnect the signal generator from the Potentiostat. Once disconnected it can be used for other experimental control tasks.
- Overload protection and overload detection are not shown. Good engineering practice demands that any possible misconnection of the cell leads will not damage the instrument. This practice has been followed in the Reference 600+ design.

Figure 3-2
Reference 600+ Signal Generation Circuitry

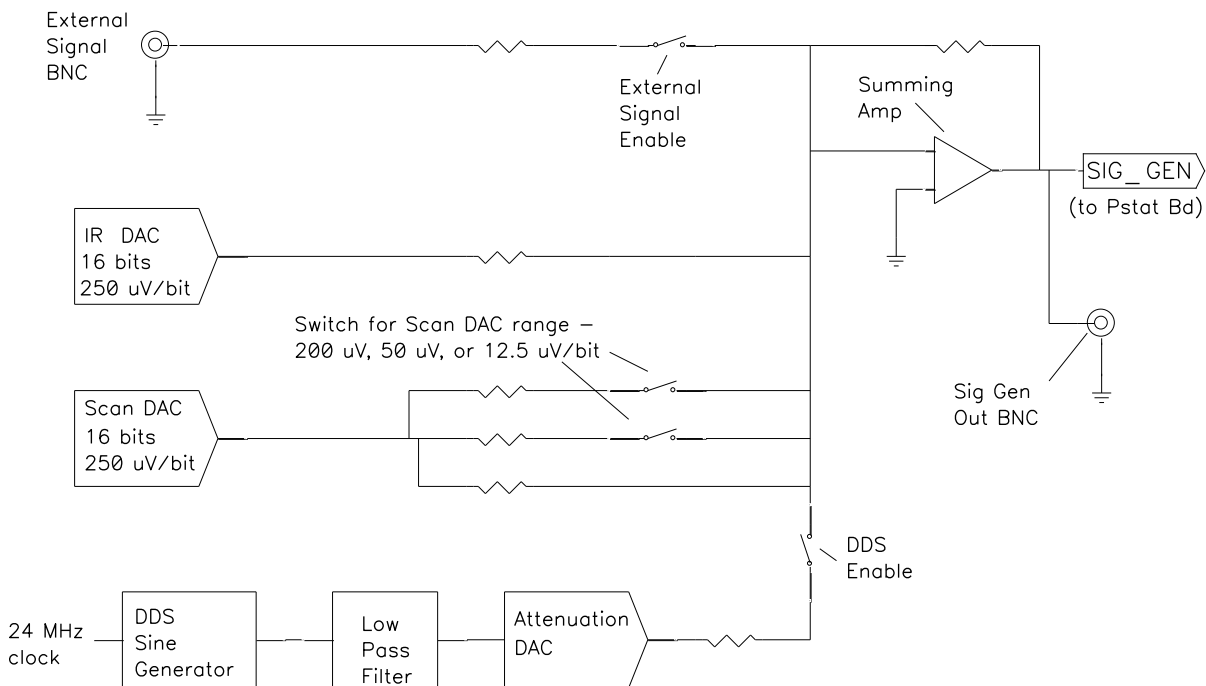

Notes on Figure 3-2:

- All the resistors summing voltages into the Summing Amplifier input do not have values shown because their values depend on scaling factors too complex for this simplified diagram.
- The IR DAC has a ± 8 V full-scale range.
- Calibration components are not shown.
- The DDS can generate fixed-amplitude sine waves with frequencies between 5 MHz and 1 mHz. In practice, Gamry's EIS software uses the Scan DAC to generate sine signals if frequency is below 1 Hz.

The low-pass filter removes high-frequency distortion in the "raw" DDS output.

The attenuator scales the DDS. The maximum output signal is 4.096 V peak-to-peak and the minimum is approximately 20 μ V peak-to-peak.

- The BNC connector for Sig Gen out is lightly filtered using an RLC circuit.

Figure 3-3
One A/D Signal Chain in the Reference 600+

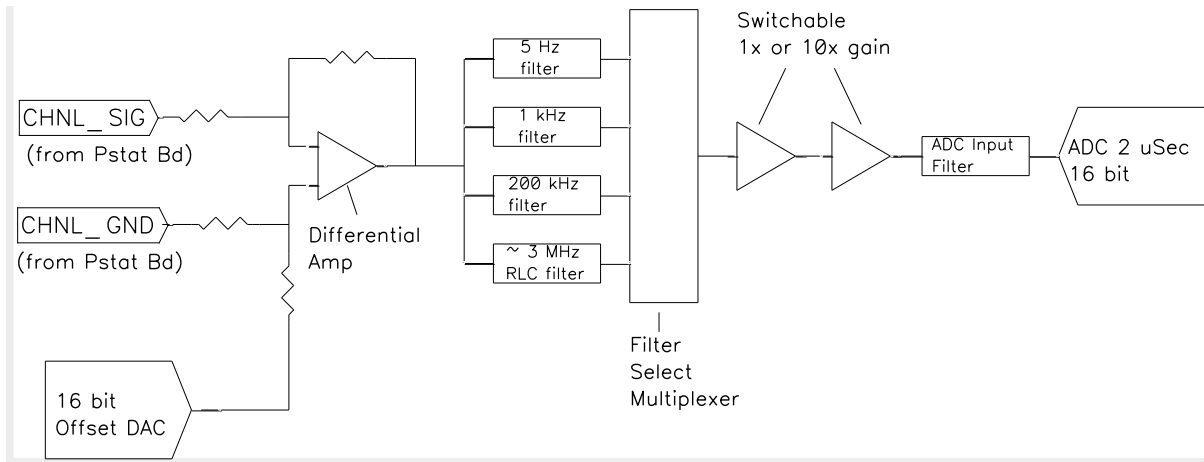

Notes for Figure 3-3:

- This diagram shows one of three identical ADC channels. One channel is dedicated to measurement of the potentiostat's current signal, another is used to measure the voltage, and the third is switched between a wide selection of possible signals.
- All three A/D converters are triggered simultaneously to start a conversion. This trigger and the pulse updating the Scan DAC voltage are under the control of a hardware state-machine. This ensures that all waveform and data-acquisition timing is tightly controlled and reproducible point-to-point.

By default, the data acquisition is synchronized with the 300 kHz power-supply switching frequency, to reduce noise from the power supply. Data-acquisition times that are a multiple of 3.333 μ s maintain this synchronization.

- All analog signals that cross from the Potentiostat Board to the Control Board or vice versa are received differentially as shown here.
- The 5 Hz, 1 kHz, and 200 kHz filters are two-pole Butterworth filters. The 3 MHz RLC filter has an arbitrarily selected transfer function.
- All signal-channel components are selected for optimal DC accuracy, low noise, and high bandwidth.

Figure 3-4
Aux Channel Input Switching

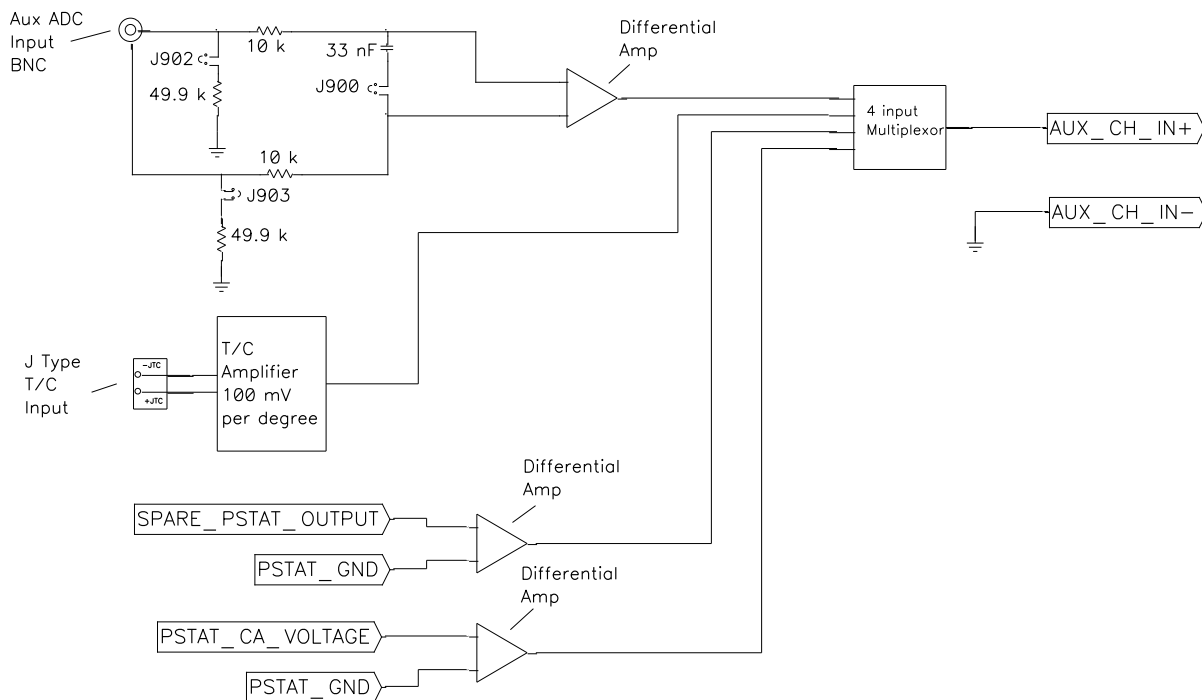

Notes for Figure 3-4:

- Two ADC Channels are dedicated to the potentiostat's voltage and current signals. This diagram shows the signals that can be connected to the third channel.
- The Aux ADC BNC input is a differential input. It is shipped configured for input impedance of 100 kΩ and unfiltered operation. Software switches allow it to be configured for high input impedance and to allow input filtering.
- The thermocouple input is a connection of a K-type thermocouple. The type of thermocouple is shown next to the connector on the rear of the instrument. Note that this circuit must be calibrated to obtain reasonable accuracy. A section of the Reference 600+ calibration procedure allows users to calibrate this input.
- The other two inputs to the Aux channel are reserved for use in future Gamry Instruments' systems.

Figure 3-5
Microprocessors in the Reference 600+

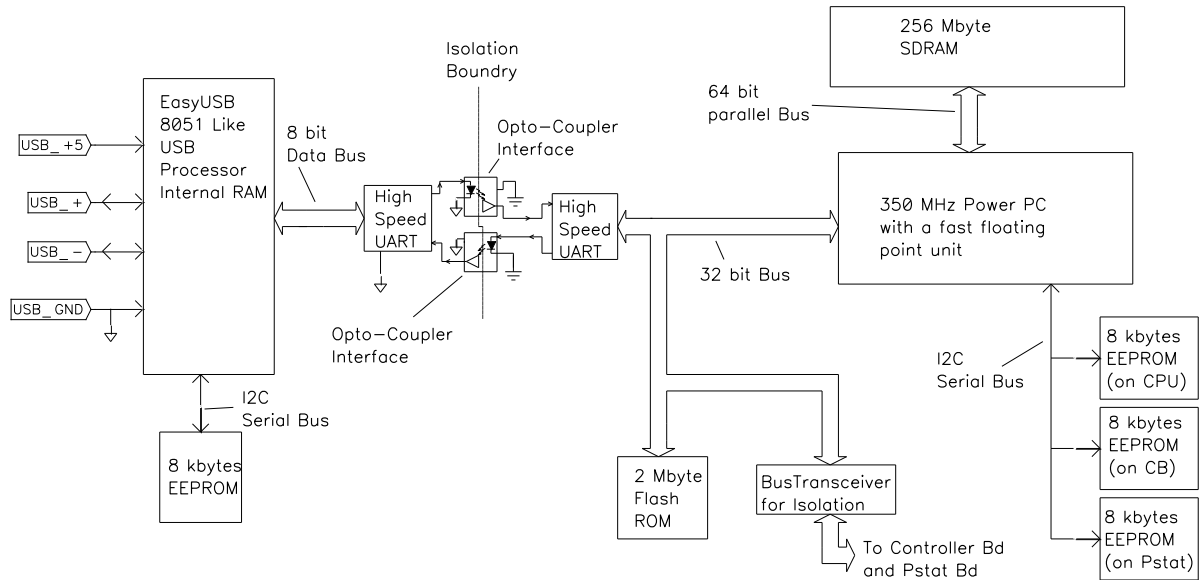

Notes for Figure 3-5:

- Note the lack of a ground connection between the USB bus and the Reference 600+ circuitry.
- The EasyUSB firmware is loaded into EasyUSB RAM on power-up. The USB firmware can be updated over the USB via Instrument Manager.
- The Power PC firmware is also transferred from ROM into RAM on power-up. The Power PC firmware also can be updated over the USB via a selection in the Reference 600+ section of the Instrument Manager. Time-critical sections of the Power PC code are kept in the processor's fast-cache memory.
- The term UART refers to a Universal Asynchronous Receiver Transmitter. It converts parallel data to a self-clocking serial bit stream. The UARTs send data at 6 Mbits/s.
- The Bus Transceiver isolates bus activity on the Controller and Potentiostat boards. Only reads and writes to locations on these boards generate bus activity. This reduces noise pick-up.
- Unlike previous Gamry Instruments' Potentiostats, the Reference 600+ calibration data are stored in the instrument, not in a data file. When a Reference 600+ is moved from one computer to another, its calibration remains valid.

Figure 3-6
DC-DC Power Conversion

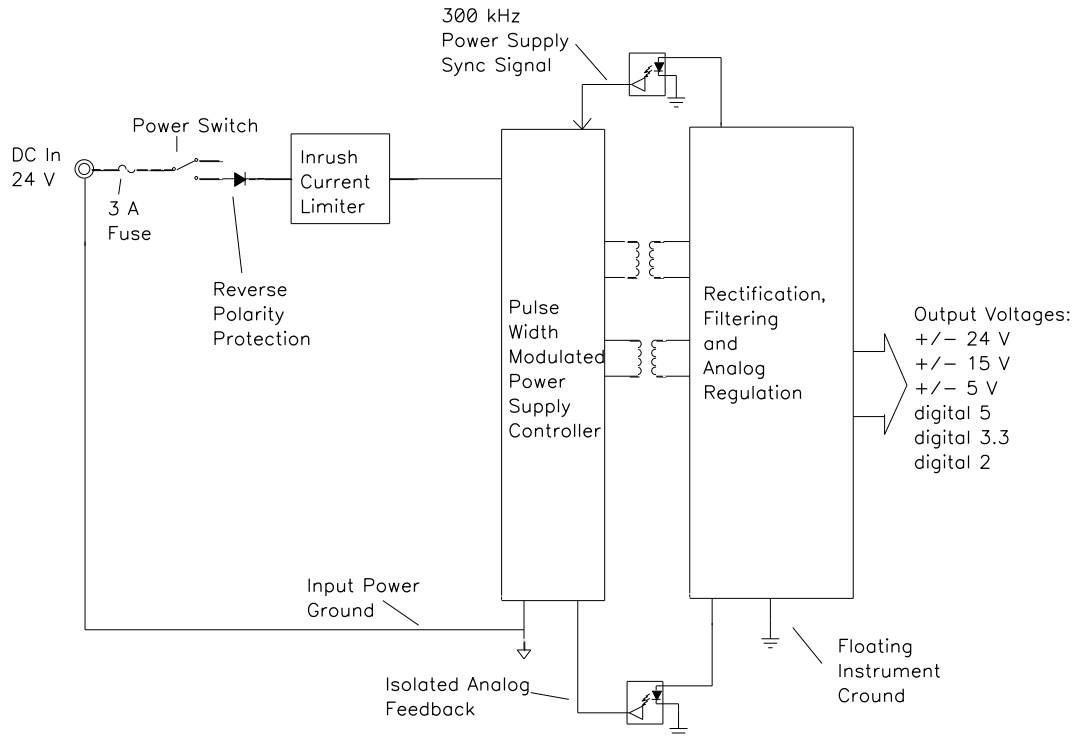

Notes for Figure 3-6:

- Note the ground isolation between the input power and the Reference 600+ circuitry. The Reference 600+ chassis is connected to the Floating Instrument Ground.
Transformers and digital isolators are the only components connected between the grounds.
- The 300 kHz power-supply sync signal is derived from the same clock used to control data-acquisition. Data points taken at an integer-multiple of 3.333 μs /point are synchronized with the power supply, minimizing the effect of power-supply noise on the data.
- Additional circuitry that is not shown protects the Reference 600+ against ESD (electrostatic discharge) and electrical surges. Note that the Reference 600+ is also protected against damage if an incorrect polarity power input is connected to the unit.
- The incoming DC voltage must be between 22 and 26 V. With inputs below 22 V, the PWM (Pulse Width Modulator) may be unable to regulate the supply. Above 26 V, the PWM may not start up.



Caution: Do not use a DC power source other than the AC adapter model provided with your Reference 600+. Other replacements may void the performance and/or safety characteristics of the Reference 600+.

Power input voltages less than 20 V or greater than 32 V can damage the Reference 600+'s power supply.

Chapter 4: Installation

This chapter of the Gamry Instruments Inc. Reference 600+ Operator's Manual covers normal installation of the Reference 600+. We assume the Reference 600+ is installed as part of a Gamry Framework-based electrochemical measurement system containing a Microsoft Windows®-compatible computer. These instructions also assume use with Gamry's Framework Software Revision 7.0 or higher.

Figure 4-1
Front View of a Reference 600+



Initial Visual Inspection

After you remove your Reference 600+ from its shipping carton, check it for any signs of shipping damage. If any damage is noted, please notify Gamry Instruments, Inc. and the shipping carrier immediately. Save the shipping container for possible inspection by the carrier.



Warning: The “reinforced insulation” that keeps the operator from accessing the “hazardous live” voltages in the Reference 600+ can be rendered ineffective if the Reference 600+ is damaged in shipment. Do not operate damaged apparatus until a qualified service technician has verified its safety. Tag a damaged Reference 600+ to indicate that it could be a safety hazard.

If the Reference 600+ is taken from a cold location (for example outdoors in winter conditions) to a warm, humid location, water vapor may condense on the cold surfaces inside the Reference 600+, possibly creating a hazardous condition. The “reinforced insulation” that keeps the operator from accessing the “hazardous live” voltages in the Reference 600+ can be rendered ineffective if the Reference 600+ has condensed water inside its case. Before connecting power to a “cold” Reference 600+, allow at least one hour for the Reference 600+ to warm at room temperature.

Physical Location

Normally, place your Reference 600+ on a flat workbench surface. Keep easy access to the rear of the instrument because some cable connections are made from the rear. The Reference 600+ is generally operated in an upright position (see Figure 4-1). Operation in other positions is possible as long as you ensure that air movement through the chassis is not restricted.



Caution: Do not block the airflow into or out of the Reference 600+ chassis. While the circuitry should suffer no damage due to excessive heat, the Reference 600+ enclosure may become uncomfortably hot to the touch if no air flows through the chassis. Running the Reference 600+ without adequate cooling could shorten the time to failure of some of the circuitry.

If you place your Reference 600+ within an enclosed space, make sure that the internal temperature within that space does not exceed the 45°C ambient temperature limit of the Reference 600+. Be particularly careful if a computer or other heat-dissipating equipment is mounted in the same enclosure as the Reference 600+.

The Reference 600+ is not designed for outdoor use.

Computer Requirements

Before you connect a Reference 600+ to a computer you must make sure that your computer meets these simple requirements.

- A computer based on one of the x86 or x64 families of Intel™ microprocessors, or a 100%-compatible processor from another vendor,
- Microsoft® Windows® 7 or newer is required with Gamry Framework™ software version 7. Framework version 6 is compatible with Windows® XP and newer. Both 32-bit and 64-bit versions of these operating systems are supported.
- A USB port that supports Full Speed (12 Mbits/second) or High Speed (480 Mbits/second) USB transfers. It must be compatible with Revision 1.1 or Revision 2.0 of the USB specification.

Quick-start Guide for System Installation

Your shipment should have included a short document entitled **Quick-start Installation Guide: USB Potentiostat**. It contains the latest instructions for installing Gamry hardware and software onto a computer system. If this document is missing, the following information should be sufficient for you to install the Gamry Framework Software and Gamry Potentiostat onto your computer.

Software Installation

The Reference 600+ is compatible with the Windows® Plug & Play configuration system. Like most Plug & Play hardware, it is best if you install the software for the Reference 600+ **before** you install the potentiostat hardware.

Gamry's software can be installed from a physical medium such as a DVD or a pre-programmed software flash drive, or it can be installed via an Internet download. The most up-to-date download can be found on www.gamry.com.

If you install from a physical medium, Gamry Software Setup program normally starts automatically when you place the Gamry Instrument's installation medium into your computer.

An Internet download of Gamry's software downloads a self-extracting .EXE file. Running this file extracts the software and begins the same installation process as you get with a physical medium.

If you have inserted the Gamry DVD or flash drive into your computer and the Gamry Setup program does not start automatically:

- 1) Navigate to the root folder of the device containing the Gamry Software (DVD or Flash Drive) or to a Windows® folder containing the Gamry Software.
- 2) Run the program called "AUTORUN.EXE" found in this folder.

If you do not know how to navigate to the Gamry Installation device, consult your local computer expert or network administrator, or email techsupport@gamry.com.

"AUTORUN.EXE" runs a set-up program. In most cases, you can choose the default choices or the most obvious choices on all screens shown during the set-up process.

Reboot your Computer after Software Installation

Reboot your computer when the Gamry Setup program is done. The Setup program normally offers you the opportunity to do so. USB device drivers usually are loaded when Windows® boots up. Following Setup, you may not be able to use your Reference 600+ until the drivers are loaded.



Device-driver installation may not occur until a while after the Windows® Desktop appears. On a slow computer, or a busy computer with lots of active applications, the delay before driver installation can be a minute or more.

Figure 4-2
Rear Panel of the Reference 600+



Power Cord and Power Connection

The Reference 600+ does not plug directly in the AC mains supply. Instead, the mains are connected to an external power supply, which supplies a regulated 24 V DC output. This regulated DC is then connected to the **Power In** jack on the rear of the Reference 600+.

The external power supply provided with the Reference 600+ is rated for operation from 100 to 240 V AC, at frequencies from 47 to 63 Hz. It should therefore be useable worldwide.

The Reference 600+ external power supply is normally supplied with a line cord suitable for use in the United States. In other countries, you may have to replace the line cord with one suitable for your type of mains (electrical outlet). You must always use a line cord with a CEE 22 Standard V (IEC 320 C13) female connector on the end of the cable leading to the unit. This is the same connector used on the US standard line cord supplied with your Reference 600+. See Chapter 1 for specific safety information regarding power-cord selection.

The DC output cord from the external power supply plugs into the **Power In** jack on the rear panel of the Reference 600+ (see Figure 4-2).

Power-up Test

Before you make any other connections to your Reference 600+, check that the Reference 600+ is at least nominally functional.

After connecting DC power to the Reference 600+, turn on the **Power** switch on the rear panel of the Reference 600+ (see Figure 4-2).

Watch the **Power** LED on the front panel as the Reference 600+ powers up. This LED should go on for a second or so, flash three times, then remain on.

The status of the other LED indicators is not important at this time.

Each flash of the **Power** LED upon startup corresponds to successful conclusion of one portion of the power-up self-test.



Caution: If the **Power** LED goes on, then turns off and stays off, the Reference 600+ is not working properly! Contact Gamry Instruments or your local Gamry Instruments representative as soon as possible if this power-up test fails.



USB Cables

The Reference 600+ connects to the computer using a standard High Speed USB A/B cable. A suitable cable was shipped with your Reference 3000. If this cable is lost, you can get a replacement at almost any computer retailer. The replacement cable should be rated for USB 2.0 high-speed USB operation.

An A/B USB cable has different connectors on each end. The end with a wider, rectangular-shaped connector plugs into a USB port on your computer (or a similar port on a USB hub). The end with a nearly-square connector plugs into the **USB** port on the Reference 600+ (see Figure 4-2).

The USB connection can be “hot-plugged”. This means both the computer and the Reference 600+ can be powered up before the USB cable is plugged in. Unlike many other instrument-to-system connections, you need not power down the system before plugging in the USB.

You can also safely remove the USB cable without powering down the Reference 600+ and your computer. Be aware however, that this may have undesirable consequences if the system is currently taking data or performing an electrochemical experiment.

Front Panel USB LED

The front panel **USB** LED provides a simple test of two aspects of normal Reference 600+ USB operation. It has three normal states:



- Unlighted The USB cable is disconnected or the USB connection is disabled by the host computer,
- Solid green A valid cable connection has been made and the Reference 600+ USB processor is receiving power from the USB cable,
- Flashing yellow Valid USB messages are being transferred between the computer and the Reference 600+.

The flashing state only occurs when Gamry Instruments application software is running.

Cell Cable Installation

The **Cell Cable** connector is a 25-pin female D-type connector on the front of the Reference 600+.

All of Gamry's standard cell cables have a 25-pin D-type connector on one end and a number of leads terminated with banana plugs on the other. The D-type connector end of the cable is connected to the Cell Cable connector on the front of the Reference 600+. Always use the knurled screws on this cable to hold the cable in place.

A wide variety of cell cables are available for the Reference 600+. These include unshielded cables designed for maximum AC performance, shielded cables in various lengths, and special cables for use in EIS systems where very low impedances must be measured. The Reference 600+ can automatically detect which Gamry Instruments cable is connected and the Gamry Framework software can then adjust the system performance for the characteristics of that cable.

Multiple Potentiostat Systems

Gamry's current Framework software (Revision 7.0) allows a computer to operate up to 16 Gamry Instruments potentiostats simultaneously. The 16 potentiostats can include Reference-family and Interface-family devices with USB connections.

A system with multiple Reference 600+ potentiostats just needs them all plugged into the computer.



We do not recommend using bus-powered hubs to expand your USB network: an externally powered USB hub is required. Suitable hubs are available at most computer retailers.

Contact our main office or your local Gamry Instruments representative if you need assistance configuring a system containing Reference 600+ hardware.

First-time Device Installation in Windows®



These instructions presume you have already installed Gamry software Revision 7.0 or higher.

Running the Framework

Regardless of your electrochemical application, Gamry recommends running the Gamry Framework after you install new Framework software or add a potentiostat to your system. The Framework Instruments Manager allows you to:

- Rename potentiostats,
- Calibrate potentiostats,
- Manage potentiostat firmware.

Run the Gamry Framework by clicking on the icon it installed on the Windows® desktop. You can connect and power any Gamry potentiostats either before or after you start the Framework.

Framework Device Status Bar

By default, the Gamry Framework shows a Device Status Bar under its main menu (Figure 4-3). If you don't see the Device Status Bar when you run the Gamry Framework, it has been disabled in the Framework **Options** menu.

Potentiostat Devices (instruments) that are connected to the computer appear on this bar. The round indicator associated with each device shows its status:

Green	The device is available to run experiments
Yellow	The device is currently running an experiment
White	The device is connected to the system, but is not usable. This is generally the result of a revision mismatch between the Framework software and the device's firmware. You can use the Framework Instrument Manager to fix the mismatch.

The screen-capture below shows a Framework screen with three USB instruments connected.

Figure 4-3
Framework with Three Potentiostats and One Running Test

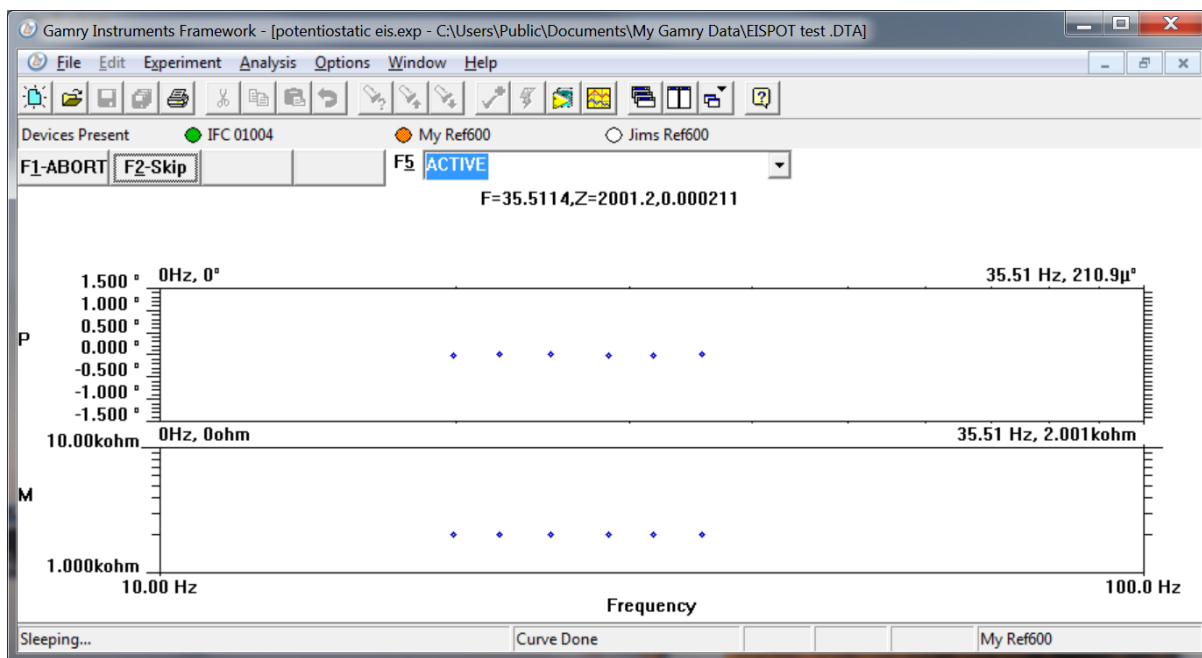

The Interface 1000 (IFC 01004) in this system is shown with a green indicator because it is installed and ready to run. The Reference 600+ labeled My Ref600 has a yellow indicator because it is recording the EIS spectrum shown on the screen. The Reference 600+ labeled Jims Ref600 has a white indicator, showing it is plugged in but cannot be used. This is an indication of a version mismatch between firmware and instrument.

Gamry Instrument Manager

You can use Gamry's Instrument Manager (GIM) application to make changes to the configuration of your Reference 600+ system. Find the application through the **Options** menu in the Gamry Framework.

Use the Instrument Manager to:

- Rename potentiostats
- Delete potentiostats that are not currently connected to the computer
- Select the order in which potentiostats appear in menus
- Update firmware within potentiostats



Close GIM before opening external Gamry programs (VFP600, ESA410, Resonator). GIM locks instruments when it is open (a blinking blue **Power** LED in the front of the instrument indicates "locked mode"). GIM must be closed in order to relinquish instrument control to other Gamry programs.

Below is an example of the **Gamry Instrument Manager** window with a Reference 600+.

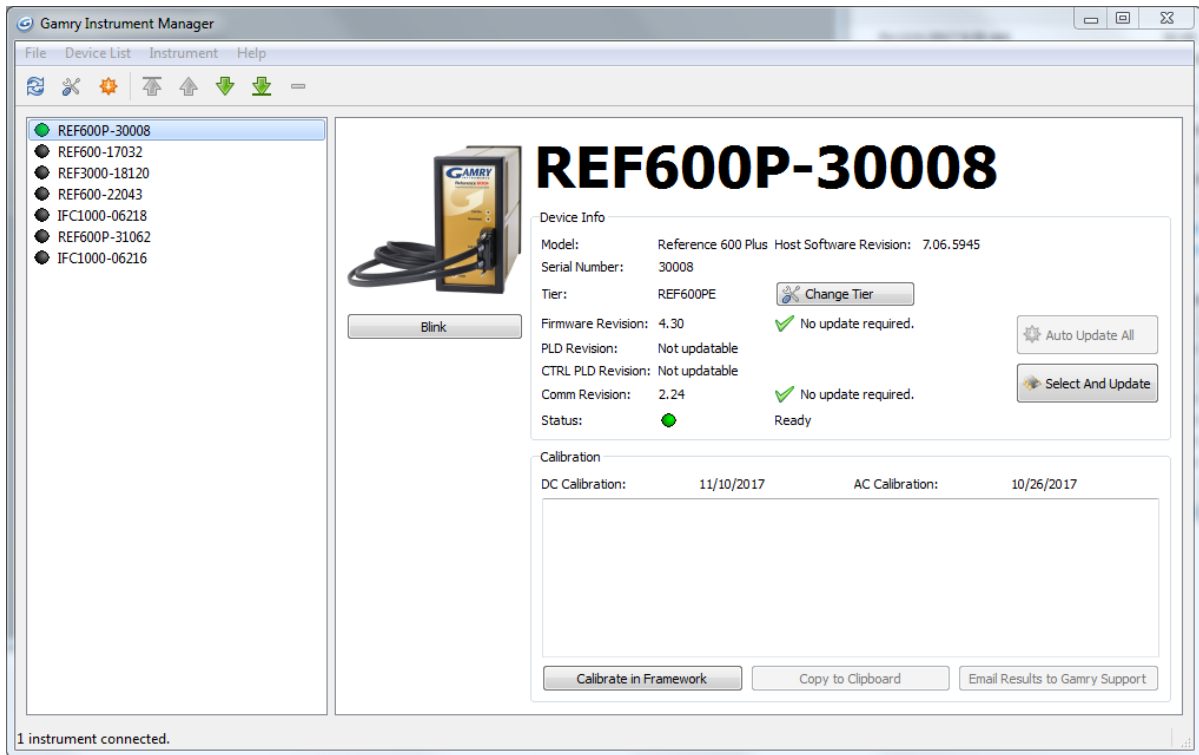

GIM appears automatically when a new instrument is connected to the computer. You can start GIM anytime by opening Framework and selecting **Options > Instrument Manager**.

GIM is always in its own window, separate from the Framework window.

Change Tier button

Use the **Change Tier** button when you upgrade an instrument from version 6 to version 7 software, or when you buy an instrument upgrade. Do the following:

- 1) Click the **Change Tier** button in the **Device Info** section of GIM.
A pop-up box appears asking you if you want to proceed.
- 2) Click the **Yes** button.

The **Authorization Code Entry** window appears. This consists of a drop-down **Package** menu and the **Authorization Code** field.

- 3) Choose the package to which you will be upgrading in the **Package** menu, and then enter the corresponding ten-digit **Authorization Code**. Gamry Instruments gives you the Authorization Code. Click the **OK** button.





A status box opens and the instrument restarts. When this is complete the instrument is at the new tier.

Firmware Update



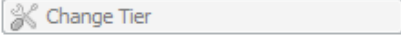



When an instrument is upgraded from version 6 to version 7 software, or when a new version of version 7 is installed, a firmware update may be required. If the firmware version on the instrument is not compatible with the version of software, the instrument will not function properly.

GIM automatically determines if the software and firmware are compatible. The status of compatibility is shown in the Device Info area.

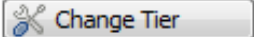
If there is a conflict, this area shows the following (here using a Reference 3000 as an example):

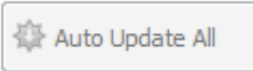
Device Info			
Model:	Reference 3000	Host Software Revision:	7.04.4758
Serial Number:	30121		
Tier:	REF3000E		
Firmware Revision:	4.00	 Warning! Version 4.15 or greater required	
PLD Revision:		Not supported	
Comm Revision:	2.24	 No update required.	
Status:		Update Required	

If the firmware is compatible with software version, the **Device Info** area appears as:

Device Info			
Model:	Reference 600 Plus	Host Software Revision:	7.06.5945
Serial Number:	30008		
Tier:	REF600PE		
Firmware Revision:	4.30	 No update required.	
PLD Revision:	Not updatable		
CTRL PLD Revision:	Not updatable		
Comm Revision:	2.24	 No update required.	
Status:		Ready	

 Reference Family instruments only use instrument and communication (comm) firmwares, and do not use a PLD firmware. Interface Family instruments use all three firmwares. Gamry does not recommend altering the firmware versions unless necessary.

Auto Update All

If no updates are required to use the instrument, this tool is grayed out. When one or more of the firmwares are incompatible, the **Auto Update All** button is active. This tool automatically selects the compatible firmwares and installs them. Gamry Instruments recommends that you use this button. To use this tool, take the following steps:

 **Caution:** Do not power off or disconnect the instrument during this process. Doing so can cause irreversible damage to the instrument.

Click the **Auto Update All** button. A window appears giving information on what version of firmware is currently installed, and what version will be installed. The install process starts automatically. After all the relevant firmwares are updated, a window appears confirming the process is complete and successful. Click the **OK** button. The instrument is now ready to be used.

Select And Update

The **Select And Update** button is available at all times, even if an update is not required. Gamry recommends not altering the firmware if it is not necessary. This tool allows you to change individual firmwares (instrument, PLD, Comm).

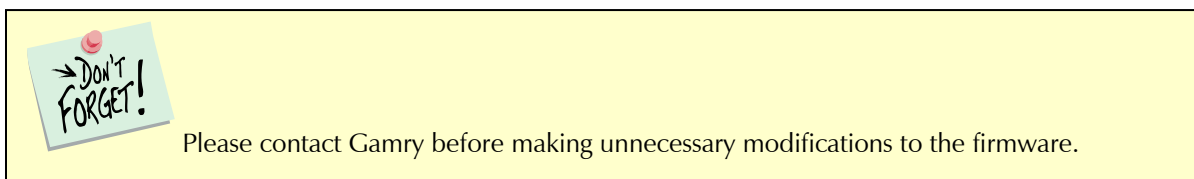

Blink Button

Clicking the **Blink** button causes the **Power** LED on the selected instrument to blink five times. This may help you identify the specific instrument chosen in the software from among a bank of similar-looking potentiostats.

Changing the Label

If you purchase additional Gamry application software, you can do so using the Framework Instrument Manager. The dialog box also allows you to change the Label for your device:

1. In Framework, choose **Options**.

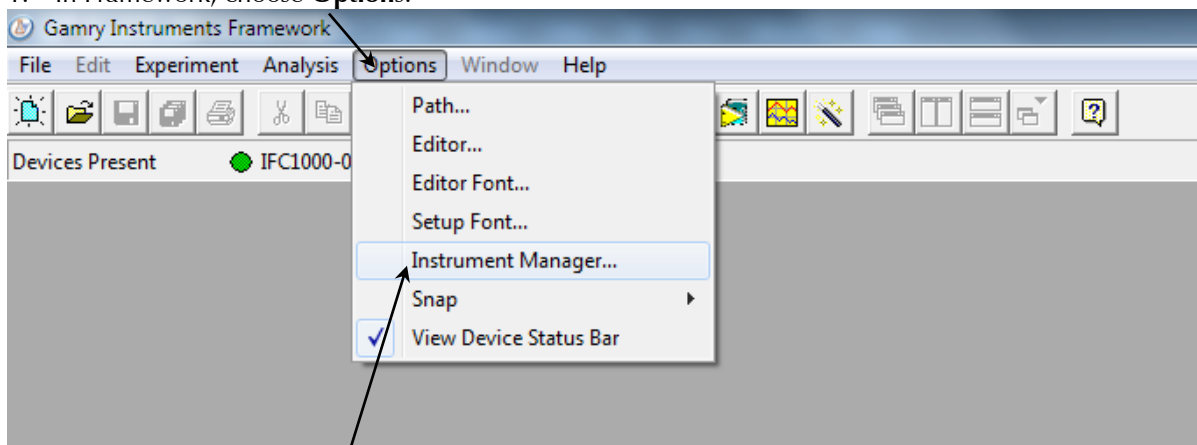

A drop-down menu appears.

2. Choose **Instrument Manager....**
The **Instrument Manager** window appears.
3. Click the instrument whose label you wish to change, to highlight that instrument.

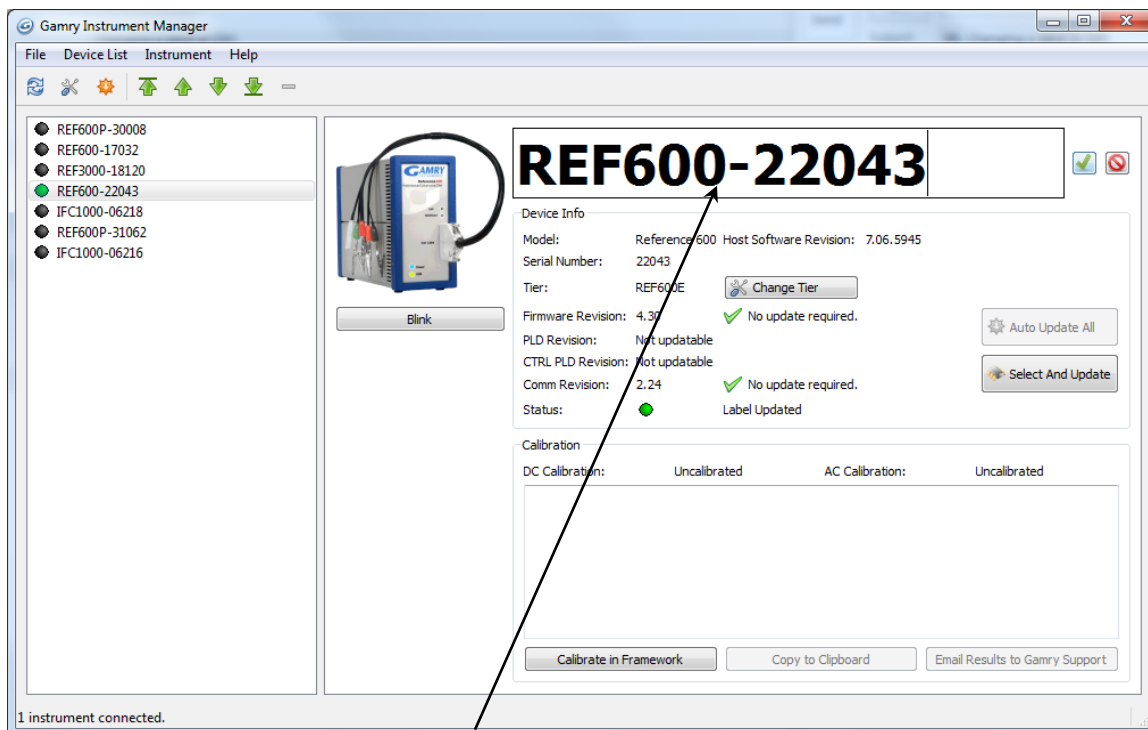

4. Click the label itself, and then enter a new, unique name.

The Reference 600+ Customization Label

Introduction to the Reference 600+ Customization Label

Battery tests are a good example of when multiple tests of a particular battery composition and/or construction are generally required. Multiple potentiostat systems are often used to speed up the testing process. If the multiple potentiostats can be randomly located in the lab, potentiostat identification can be a problem. You may need to know “Is the potentiostat to the left of my host computer the second or third potentiostat in the system?”

The Reference 600+ includes a customization label that makes each unit visually unique. This allows you to know exactly which potentiostat will be used for each test. You can easily place other labels in the instrument’s Customization Label area. In a system containing eight potentiostats, the potentiostats might be labeled **Pstat 1, Pstat 2, Pstat 3, ... Pstat 8**.

Insert simple paper labels in an area behind the clear plastic outer layer of the front panel. The paper is behind the plastic, so it is not affected by the lab environment. Best of all, you can edit or print the labels so personal labels, like **Bob’s Stat**, are also possible.

Label Sheet Provided with Each Reference 600+.

Every Reference 600+ is shipped with a preprinted label sheet containing:

- Instructions on how to change the label
- The first eight letters of the Greek alphabet (alpha through theta)
- The eight planets in the solar system (Mercury through Neptune)
- Several blank white labels
- Pstat 1 through Pstat 16 on a blue background
- Pstat 1 through Pstat 16 on a red background

You can cut any of these labels from the sheet and insert as the Reference 600+ Customization Label. The white labels are provided to allow you to handwrite a label.

Procedure to Change a Label

If you are making a custom-printed label, edit the Excel® file and print a label sheet as described above. If you are using the Gamry-supplied label sheet, identify the location on the sheet where the new label is found.

- 1) If you are writing by hand on a blank label, do it now.
- 2) Use scissors to cut out the new label. Cut white labels on the black lines.
- 3) Unscrew the four Philips-head screws on the front bezel, and remove the instrument's front bezel (the black frame around the front panel). See Figure 4-5.

Figure 4-5
Removing the Front Bezel



- 4) Your instrument should now look like Figure 4-6 (the front bezel is removed). Notice the white tab on the left side on the instrument. This is part of the old label.

Figure 4-6
Instrument with Bezel Removed - Label Tab Seen

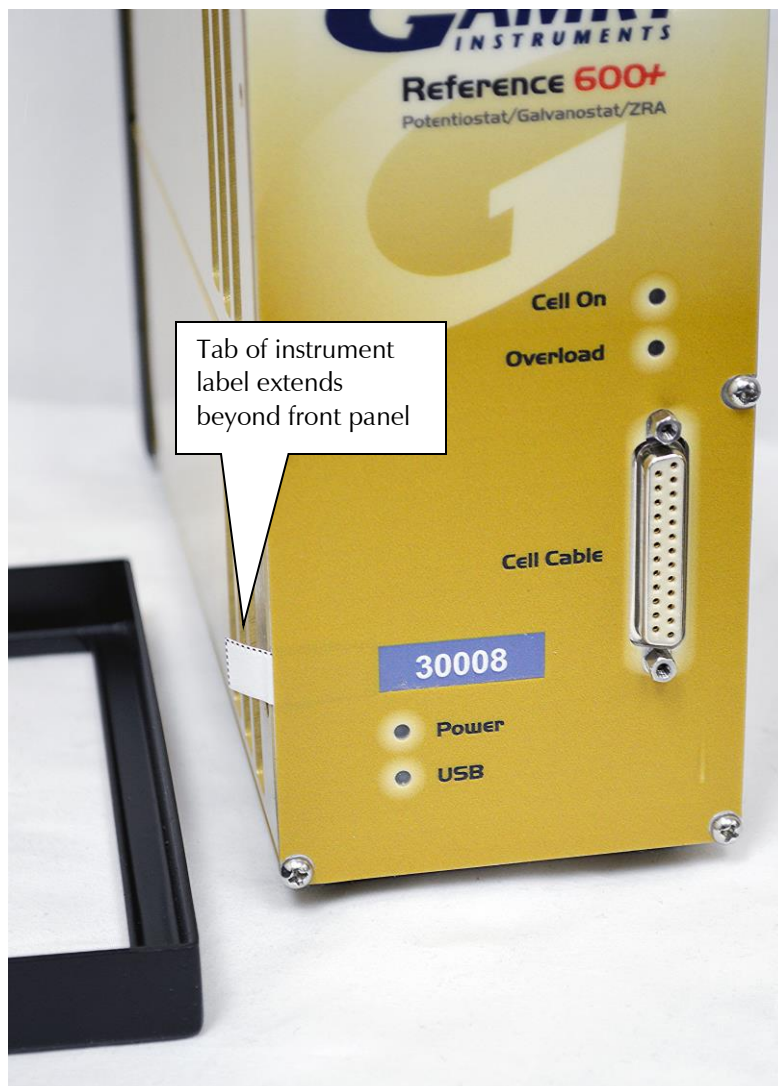

- 5) Pull gently on the paper tab on the left side of the front panel to remove the existing label. You need to pull out about 5 cm of label.
- 6) Insert the new label in the same spot as the old label. The text should face the front of the instrument. A small tab of paper extends beyond the instrument's front panel.
- 7) Examine the new label's position in the Front Panel. Adjust the label if needed.
- 8) Replace the black bezel. Reattach the four screws to fix the bezel in place.
- 9) Rename the Reference 600+ in the Gamry Framework software to match the new label. Use the Framework **Options, Instrument...** dialog box. In the resulting dialog box, select the device you want to rename and then select the **Device Settings...** button.

Chapter 4: Calibration

Introduction

There are three different types of calibration for the Reference 600+ potentiostat:

- Instrument DC and AC calibration
- Cable calibration
- Low I Range DC Calibration

Calibration can be initiated through Framework™ software, or directly through Gamry Instrument Manager (GIM). Gamry recommends calibrating the instrument at least once per year, or when the quality of your data is in question. To initiate calibration, take the following steps:

Click the **Calibrate in Framework** button, located in the Calibration area of GIM. This launches the appropriate calibration routine for the instrument selected in GIM. Follow the instructions given in Framework. See the relevant Calibration Quick Start Guide for additional details.

If there are any failures during calibration, click the **Email Results to Gamry Support** button in GIM. One of our support engineers will review the results and provide appropriate advice.

You run the Instrument Manager by selecting **Options/Instrument Manager...** on the Framework Menu.

Calibrate each potentiostat installed in your system. A calibration utility is provided with the Gamry Framework.

The calibration for the Reference 600+ has been divided into three sections: Instrument DC and AC Calibration, cable calibration, and Low I DC Cal. Gain access to all three calibration procedures via the **Utility** selection on the Framework's **Experiment** drop-down menu.

The Reference 600+ recognizes the type of cable connected to its cell connector. It maintains a separate AC calibration table for each type of cable. The Gamry Framework will not let you use AC calibration data recorded using a 60 cm shielded cable for experiments run using a Twisted Pair cable optimized for low-impedance EIS measurements.

Instrument DC and AC Calibration

These two procedures use an external resistive Calibration Cell.

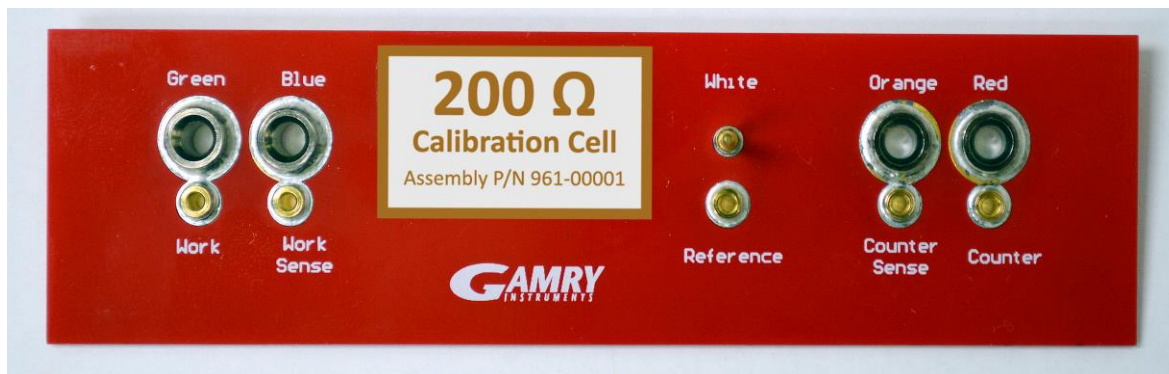



Caution: The standard Reference 600+ calibration calls for an external resistive dummy cell. Your Reference 600+ was shipped with a 200 Ω Calibration Cell, which includes a 200 Ω , 0.05% accurate resistor. After calibration, please place this Calibration Cell in a safe place where you can find it if your unit requires recalibration.

If you do need to recalibrate and you cannot find your Calibration Cell, you can perform DC Calibration using a different 200 Ω resistor. Its power-rating is unimportant. Some performance checks in the calibration process may fail if the resistor's inaccuracy exceeds 0.2% (0.4 Ω).

We do not recommend AC Calibration with any resistor other than the one on the Calibration Cell. The Calibration Cell was designed to separate the working electrode leads from the counter and reference electrode leads. If you perform AC Calibration without adequate separation between these leads, you will see a phase-shift in your high-frequency EIS data. 1.4 pF of stray capacitance across a 200 Ω resistor causes a 1° phase-shift at 1 MHz.

Potentiostat calibration is only required infrequently. Recalibrate your Reference 600+ under the following circumstances:

- It is at least one year since your last calibration.
- Your potentiostat has been serviced.
- You notice breaks or discontinuities in the data curves recorded with your system.
- The system is being run in an environment that is very different from the previous operating environment. For example, if the Reference 600+ was calibrated at 15°C and you are now operating it at 30°C, you should recalibrate.

Figure 4-4
200 Ω Calibration Cell with Leads Attached for Calibration

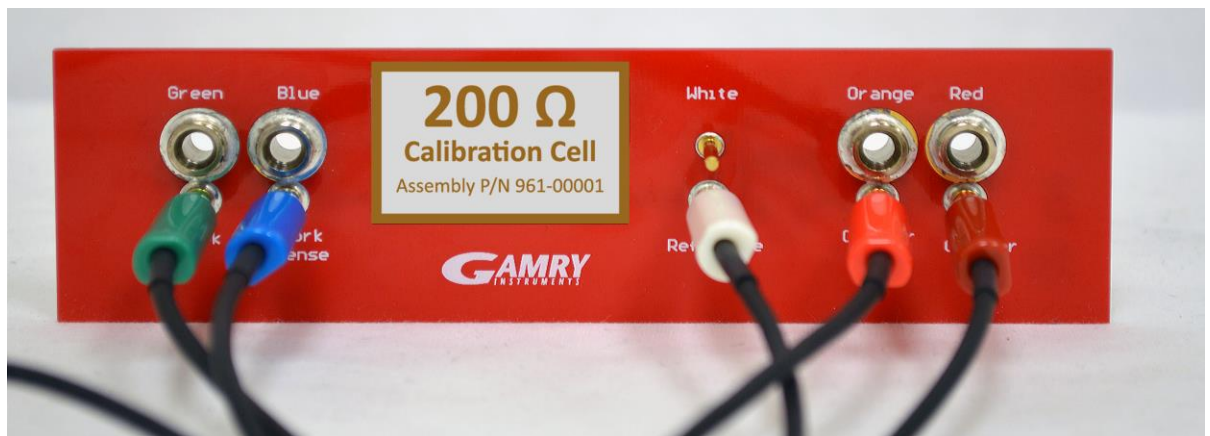

Cable Calibration

This procedure uses an external resistive Calibration Cell.



Caution: The Reference 600+ cable calibration calls for an external resistive dummy cell. Your Reference 600+ was shipped with a 20 k Ω Calibration Cell including a 20 k Ω , 0.05% accurate resistor. After calibration, please place this Calibration Cell in a safe place where you can find it if your unit requires recalibration.

The cable calibration cell is a different cell (20 k Ω) than standard instrument calibration (200 Ω).

Cable calibration is only required infrequently, if you feel that the cable capacitance is a problem for your experiments, especially if you see excessive phase glitches on high-impedance samples.

Procedure to calibrate the cable

- 1) Connect the **Chassis Ground** on the back of your potentiostat to a known, good earth ground.



- 2) Connect the cell cable to the correct color-coded receptacles on the 20 k Ω Calibration Cell.

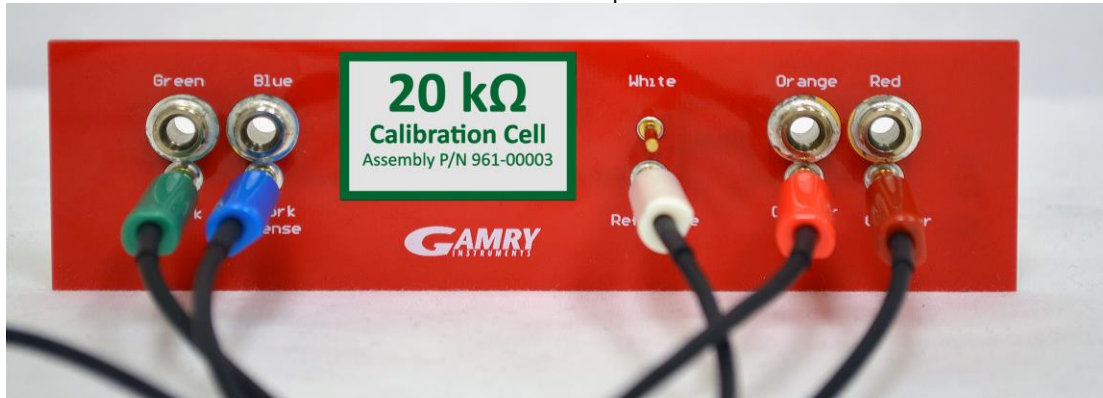

- 3) Place the Calibration Cell inside the Calibration Shield, close the lid, and connect the black floating-ground lead of your cell cable to the Shield's grounding post. (Note that the photograph below left is of a 200 Ω cell, so is only a general representation of the procedure.)

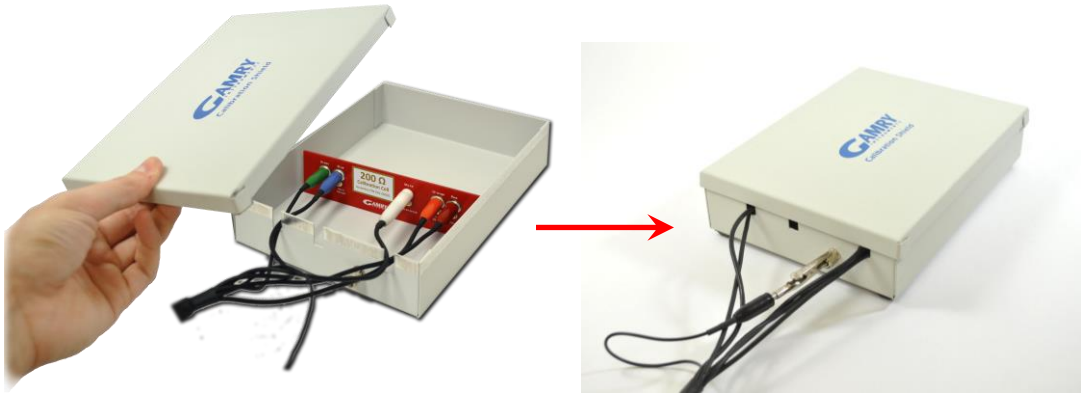

- 4) Open Gamry Framework™ software. Select **Experiment > Named Script...**

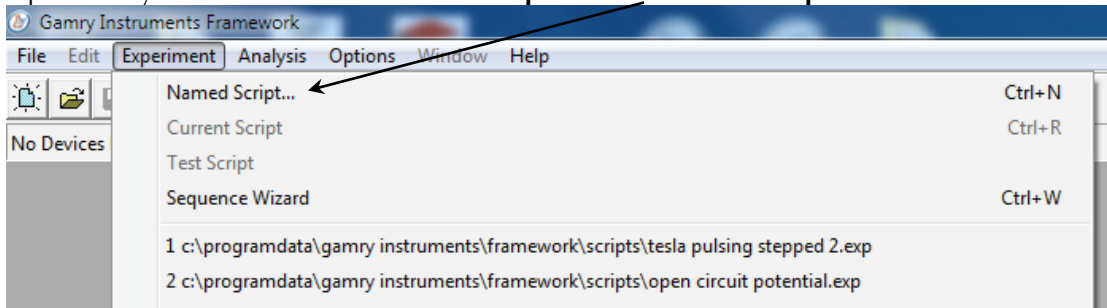

The **Select a script to run** window appears.

- 5) From the list of scripts, choose **calcable.exp**, then click the **Open** button.

The **Cable Capacitance Calibration** window appears.

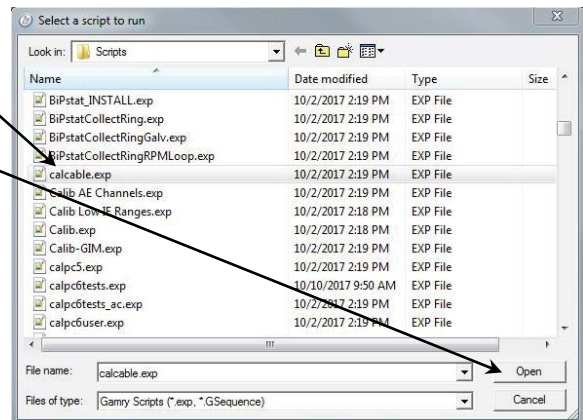

- 6) In the **Cable Tag** field, enter a unique name for the cable you are calibrating. Choose the desired **Action** radio button:
- To calibrate the cable, choose **Cal Cable**.
 - To reset the vales to zero (if, say, the calibration doesn't work), choose **Zero Values**.
- Click the **OK** button.

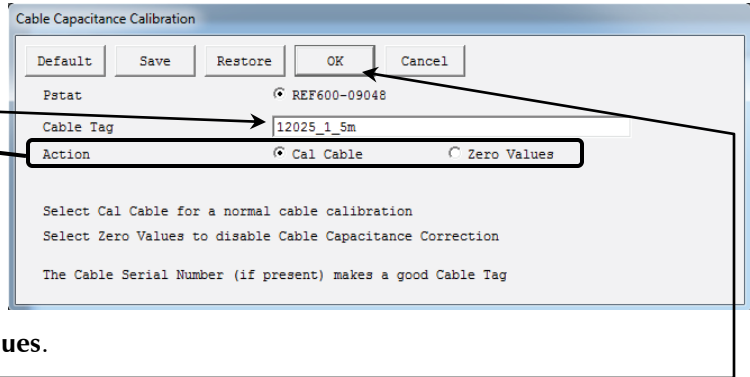

- 7) Make sure that all of the tips are true, then click the **OK** button.

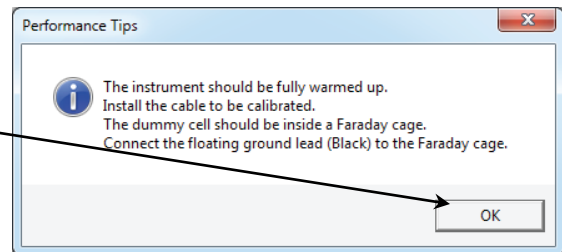

- 8) Make sure that the correct Calibration Cell is attached, then click the **OK** button.

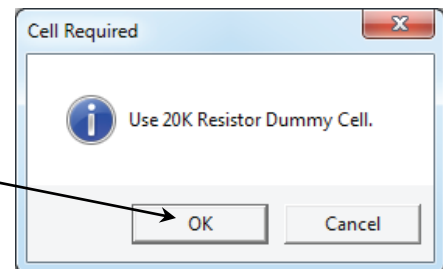

The calibration runs.

- 9) Click the **OK** button to acknowledge completion.

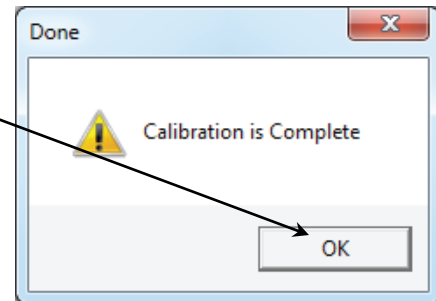

Low I Range DC Calibration

The standard Reference 600+ calibration is performed with the cell leads connected to a 2 k Ω resistor. During the calibration procedure, DC current-range offsets are recorded with the cell switch turned off. A DC current measurement is made on each of the eleven current ranges in the Reference 600+. The measured current on each range is the sum of current contributions from:

- The input current of the I/E Converter input amplifier,
- The input current of the Working sense input amplifier,
- The input current of the Reference input amplifier,
- The input current of a Counter Sense input amplifier, and
- Current leakage in the cell switch.

In most real-world experiments, the cell is turned on, and the I/E converter does not measure the last three terms listed above. These currents still exist, but they are generally sourced by the low-impedance counter

electrode lead. During Low I DC Calibration, the first two terms are directly measured in order to improve picoampere accuracy of the instrument.

The current contributions from each source on the above list are (at most) a few pA, so they are insignificant on all but the most sensitive Reference 600+ current ranges: the 60 pA and 600 pA ranges. This effect can cause differences of up to 8 pA between DC current measured with the cell turned off and current measured with the cell turned on. In most cases the difference is smaller: one or two pA.

Only two Reference 600+ applications are sensitive enough that this current-measurement offset causes problems:

- Physical Electrochemistry (Cyclic Voltammetry for example) with small electrodes
- EIS on high-impedance samples such as barrier coatings.

Incorrect DC-current readings in EIS can slow the experiment, because the automatic ranging algorithms in the EIS software can make poor choices regarding ranges, giving incorrect data. This can significantly lengthen the time needed to measure an EIS spectrum.

Most corrosion experiments or macro-electrode measurements involve currents much too large to be affected by this difference.

The Gamry Framework includes a special “Low I DC Current” calibration procedure that corrects the Reference 600+ offsets to minimize this problem. The procedure uses a script that:

- 1) Asks you to disconnect the reference, counter, and counter sense leads from the calibration cell,
- 2) Measures the I/E input and Working sense amplifier input currents on the 60 pA and 600 pA ranges,
- 3) Replaces the 60 pA and 600 pA current range offsets measured in the full DC calibration with these improved values.

The error sources listed above are both time- and temperature-dependent, so we recommend frequent “Low I DC Calibration”—**if** you need accurate measurement of absolute currents at pA levels. The procedure runs fairly quickly, so daily or weekly calibration ought not be too inconvenient.



The Low I DC Calibration is not a full calibration. You must run a **full** DC Calibration on your Reference 600+ **before** you run the Low I DC calibration. Remember that the Reference 600+ must have a full DC calibration on the **same type of cable** you use for the Low I DC Calibration.

Chapter 5: Cell Connections

Normal Cell Connections

Each Reference 600+ in your system was shipped with a standard, shielded cell cable (part number 985-00071). It is a 60 cm complex cable with a 25-pin D-type connector on one end and four banana plugs and two pin jacks on the other end.

In some cases, your system may also include a special-purpose cell cable. The special-purpose cell cable includes documentation describing its use.

The 25-pin male end of the standard cell cable connects to the Reference 600+'s front panel Cell Cable connector. Always screw the cell cable into place, because this cable can fall off the unit. **Disconnection can be disastrous if it occurs during an experiment.**

The other end of the cell cable terminates in a number of banana plugs and two pin jacks. Each termination comes with a removable alligator clip. Table 5-1 identifies each terminal of the cable.

Table 5-1
Cell Cable Terminations (Potentiostat and Galvanostat Modes)

Color	Type	Name	Normal Connection
Blue	Banana Plug	Working Sense	Connect to working electrode
Green	Banana Plug	Working Electrode	Connect to working electrode
White	Pin Jack	Reference	Connect to reference electrode
Red	Banana Plug	Counter Electrode	Connect to counter electrode
Orange	Banana Plug	Counter Sense	Used in ZRA mode; connect to counter electrode
Black	Pin Jack	Floating Ground	Leave open or connect to a Faraday shield

Connect both the blue and green cell leads to the working electrode. The working electrode is the specimen being tested. The blue pin jack connection senses the voltage of the working electrode. The green working electrode connection carries the cell current. The working electrode may be as much as 150 mV above the circuitry ground (floating ground).

Connect the white pin jack to the cell's reference electrode, such as an SCE or Ag/AgCl reference electrode. The measured cell potential is the potential difference between the blue and white cell connectors.

Connect the red banana plug to the counter or auxiliary electrode. The counter electrode is usually a large inert metal or graphite electrode. The counter electrode terminal is the output of the Reference 600+ potentiostat's power amplifier.

The orange lead is only used in ZRA mode, where it senses the counter electrode potential (see following section). Automatic switching to ZRA mode is possible if this lead is connected to the counter electrode. If you are not using ZRA mode, this lead may be left open as long as you insure that it will not short against any other electrode.

The black pin jack is connected on the Reference 600+ end to Floating Ground. This is the circuitry ground for the analog circuits in the Reference 600+. In most cases, leave this terminal disconnected at the cell end. When you do so, take care that its metal contact does not touch any of the other cell connections.

If your cell is a typical glass laboratory cell, all of the electrodes are isolated from earth ground. In this case, you may be able to reduce noise in your data by connecting the Reference 600+ 's Floating Ground to an earth ground.



Caution: If any electrode in your cell is at earth ground, **never** connect the Reference 600+ chassis to earth ground. Autoclaves, stress apparatus, and field measurements may involve earth-grounded electrodes. A binding post on the rear panel of the Reference 600+ is provided for this purpose. A water pipe can be a suitable earth ground.



Warning: Make sure that your earth-ground connection is made to a legitimate source of earth ground. Consult a qualified electrician if you are uncertain how to obtain an earth ground. Connecting the Reference 600+ to an incorrect and unsafe voltage can create a safety hazard (see Chapter 1 for details).

If you are measuring very small currents, you may find that a metal enclosure completely surrounding your cell (a "Faraday shield") significantly lowers measured current noise. You should normally connect this Faraday shield to both earth ground and floating ground. The floating ground on the black cell lead is a convenient source of ground.

If any electrode in your cell is connected to earth ground, **only** connect your Faraday shield to the black cell lead (Floating Ground).

In either potentiostatic or galvanostatic mode, if you do not have a reference electrode in your cell, the reference lead can be connected to the counter electrode for a two-electrode experiment. The potential reading will be the difference between the counter electrode and the working electrode.

ZRA Mode Cell Connections

The Reference 600+ can function as a precision Zero Resistance Ammeter (ZRA). As a ZRA, it maintains two metal samples at the same potential and measures the current flow between the samples. It can also measure the potential of the samples versus a reference electrode. The cell cable connections for ZRA mode are shown in Table 5-2. Note that the connections are very similar to those for the potentiostat and galvanostat modes. A second working electrode is substituted for the counter electrode, and the Orange Counter Sense lead **must** be connected.

**Table 5-2
Cell Cable Connections for ZRA Mode**

Color	Type	Name	Normal Connection
Blue	Banana Plug	Working Sense	Connect to metal sample #1
Green	Banana Plug	Working Electrode	Connect to metal sample #1
White	Pin Jack	Reference	Connect to a reference electrode
Red	Banana Plug	Counter Electrode	Connect to metal sample #2
Orange	Banana Plug	Counter Sense	Connect to metal sample #2
Black	Pin Jack	Floating Ground	Leave open or connect to a Faraday shield

The counter sense and the working sense lead are each connected to different metal samples. In ZRA mode, the Reference 600+ is normally programmed to maintain zero volts between these leads. It therefore maintains the two metal samples at the same voltage.

The white pin jack on the cell cable is normally connected to a reference electrode. The potential between this lead and the working sense lead is reported as the cell potential.

In ZRA mode, if you do not have a reference electrode in your cell, we recommend that you connect the white reference lead to the working electrode. In theory, the measured potential is exactly zero when this is done. In practice, A/D noise and offset create a small potential signal with a value very close to zero.

Membrane Cell Connections

The Reference 600+ can be used with membrane cells. In this type of cell, a membrane separates two electrolyte solutions. Two reference electrodes are used: one in each electrolyte. Each electrolyte also contains a counter electrode. The Reference 600+ controls the potential across the membrane. Table 5-3 shows the cell connections used with a membrane type cell.

**Table 5-3
Cell Cable Connections for a Membrane Cell**

Color	Type	Name	Normal Connection
Blue	Banana Plug	Working Sense	Connect to reference electrode #1
Green	Banana Plug	Working Electrode	Connect to counter electrode #1
White	Pin Jack	Reference	Connect to reference electrode #2
Red	Banana Plug	Counter Electrode	Connect to counter electrode #2
Orange	Banana Plug	Counter Sense	Leave open (only needed in ZRA mode)
Black	Pin Jack	Floating Ground	Leave open or connect to a Faraday shield



Reference electrode #1 and counter electrode #1 must be on one side of the membrane, and reference electrode #2 and counter electrode #2 must be on the other side.

Chapter 6: Panel Indicators and Connectors

Front Panel

The Reference 600+ front panel includes one connector and four backlit LED indicators.

Cell Cable Connector

The **Cell Cable** is a 25-pin D-type connector that is used to connect the Reference 600+ to an electrochemical test cell. It is normally used with a Gamry Instruments-supplied cell cable.

In addition to the pins used for cell connections, the Reference 600+ Cell Connector also uses five pins to read a cell cable ID. Gamry's software compensates for the cell-cable characteristics for optimal system performance, especially in EIS (Electrochemical Impedance Spectroscopy).

See Chapter 2 for more about cell connections. There is a pin-out diagram of the cell-cable connector in Appendix B.

The Power LED

The **Power** LED is on the lower left of the Reference 600+ front panel. It normally glows a steady blue, after the Reference 600+ is turned on and has passed some simple self-tests.

When the Reference 600+ is first turned on, the **Power** LED glows steadily for a second or two, blinks three times, and then enter its normal steady blue output. Each blink in this sequence indicates successful completion of a portion of the power-up self-test routine.

A Reference 600's **Power** LED blinks when that instrument is selected in the Framework's Instrument Manager. This allows easy identification of a specific instrument in a MultEchem system without looking at the instrument Serial Label on the bottom of the instrument chassis.

When the **Power** LED is off, several possibilities exist:

- The rear panel power switch is off.
- There is no DC +24 V supply connected to the rear-panel **Power In** connector.
- The external DC power supply has no input power or is malfunctioning.
- One part of the Power PC's power-up self-test has failed.

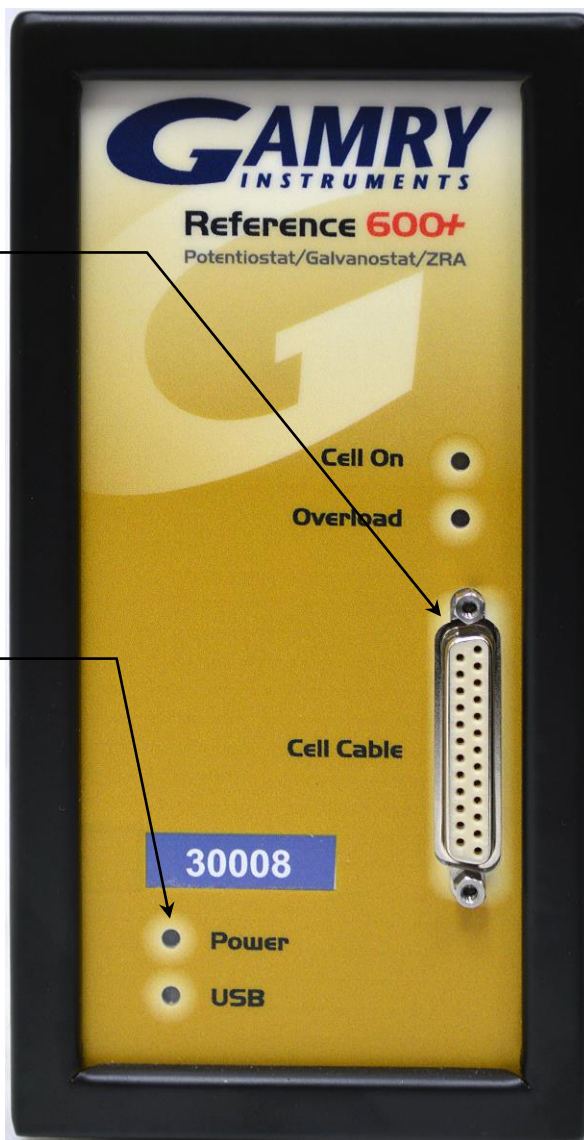

Caution: The **Power** LED is used to indicate power status, to indicate that power-up tests have passed. Never rely on the **Power** LED as a true power status indicator. Always unplug the **Power In** connection if you suspect your Reference 600+ is malfunctioning.

The USB LED

The **USB** LED is located just below the **Power** LED. It is a tri-color LED, capable of glowing green, orange, or red.

The **USB** LED is unlit when:

- The Reference 600+ is not powered.
- The Reference 600+ does not have a USB cable plugged into the **USB** port on the rear panel.
- The computer end of the USB cable is not plugged into a USB port on a computer or hub.
- The USB cable is not supplying USB power to the Reference 600+.
- The computer has disabled the USB port going to the Reference 600+.

The **USB** LED glows a steady green if a valid USB connection has been made and the Reference 600+'s communication processor is receiving power along the USB cable.

The **USB** LED flashes orange whenever the Reference 600+ is receiving or transmitting valid USB messages to or from the host computer. It does not flash if there is USB traffic addressed to other devices on the USB bus, including messages aimed at a different Reference 600+.

The **USB** LED indicates a solid red in one special condition: when a firmware download is taking place.



Caution: Interrupting a firmware update can cause a catastrophic failure of your system. **Do not turn off the Reference 600+, do not unplug the USB cable, and do not stop the operation of the host computer when the USB LED is a continuous red color.**

Do not interrupt a firmware update that is in progress. An incomplete update can render a Reference 600+ inoperable until it is returned to Gamry for reprogramming.

Should the firmware update be interrupted, contact Gamry before starting the return process.

Cell On LED

The **Cell On** LED glows yellow whenever the Reference 600+ is actively applying voltage or current to the electrochemical cell attached to the Cell Cable. Avoid touching the cell cable leads whenever the **Cell On** LED is lit, because the quality of the data being collected in your experiment may be compromised.



The **Cell On** LED does not indicate a dangerous condition when it is lighted. The voltages put out by Reference 600+ are generally considered safe. Still, avoid touching the cell leads when the cell is on.

If you need to make changes to your cell leads, you normally do so between experiments, when the **Cell On** LED is off and the potentiostat is inactive.

In a typical experimental sequence, the **Cell On** LED is off between experiments and during any open circuit potential measurements. It glows yellow whenever the cell is polarized.

Overload LED

The **Overload** LED is normally unlit. When it glows red, some circuit in the Reference 600+ has exceeded its normal operating limit. Conditions that generate Overloads include:

- The absolute value of the differential electrometer output voltage (the difference in voltage between the Working and Reference leads) exceeds 10 V. This condition is known as an E Overload.
- The control amplifier has lost control of the cell. The absolute value of the cell current may be trying to exceed ± 600 mA, or the absolute value of the counter electrode voltage may be trying to exceed ± 22 V. Either condition is called a Control Overload.
- The absolute value of the cell current has exceeded full scale on the current range presently in use. This condition is known as an I Overload.

Transient (temporary) overloads **during** an experiment in which the cell voltage or current is being stepped or swept are often normal. In most cases, they **do not** indicate a system or instrument malfunction.

Consider the case of an infinitely fast voltage step into a perfect capacitor. In theory, charging the capacitor requires an infinite current. The current spike seen at each step in a stepped voltage waveform can easily illuminate the **Overload** LED. The current spike normally decays to near zero before the actual current and voltage readings are taken.



Overload indications when the cell is being connected or disconnected are common and usually do not indicate a problem. Overloads can also be seen when one of the cell leads is disconnected from the other cell leads, even though the cell is off. Again, this does not indicate a problem.

A steadily glowing Overload LED **during** an experiment most likely indicates a problem is occurring. Possible causes include:

- One of the cell leads is disconnected (this is the most common cause),
- A gas bubble in the cell is blocking one of the electrodes, or
- The potentiostat could be oscillating (see the next chapter).



A glowing red **Overload** LED does not necessarily indicate a system malfunction. The **Overload** LED can illuminate when one or more cell leads are disconnected, without indicating a problem with the system. The **Overload** LED can often illuminate momentarily during a swept or stepped experiment. The only **Overload** LED indication that definitely points towards a problem is a continuously glowing **Overload** LED during an experiment.

Rear Panel

The rear panel contains one switch and a large number of connectors.

Power In Jack

The Reference 600+ derives all its power from +24 V DC input through the **Power In** jack. The input current is less than 3 A.

Always use the external power supply supplied with your Reference 600+ to supply DC power to the instrument. This supply is rated for operation from 100 to 240 V AC, at frequencies from 47 to 63 Hz. It should therefore be useable worldwide. While a Reference 600+ may work with other power sources, we cannot guarantee it will work to its full specifications.

If you have to use the Reference 600+ with a different supply, make sure that the supply is regulated, has an output between 22 and 26 V, and supplies 3 A of load current.



Caution: Power input voltages less than 20 V or greater than 32 V can damage the Reference 600+'s power supply.

Power Switch

The **Power** switch is just below the **Power In** jack. It



switches the power from this jack to the input of the Reference 600+'s DC-DC converter. All protection circuitry, including the in-rush current limiter, are located after this switch.

Normally, the DC power is connected before the **Power** switch is turned ON. However, no damage occurs if this switch is already in the ON position when the **Power In** cable is connected, or the AC power input is connected to the external power supply.

Chassis Ground

The rear panel **Chassis Ground** is intended for one use only. When the Reference 600+ is used with cells isolated from earth ground, connecting the chassis ground to earth ground may lower the noise measured in the system. Note that the chassis of the Reference 600+ is connected to Floating Ground. See Chapter 1 **Error! Reference source not found.** for safety information concerning this connection.

Either a banana plug or the stripped end of a wire can be connected to the **Chassis Ground** binding post. The other end of the wire is then connected to earth ground.

A black banana-plug to banana-plug lead has been provided with your Reference 600+. You may find it useful when making this earth ground connection.

USB Port

The **USB** port on the rear panel of the Reference 600+ is a Type B connector as defined in Revision 1.1 and 2.0 of the USB Specification. Use a standard, shielded, Type A/B cable to connect this port to a computer's USB port or a USB hub (preferably an externally powered hub). The two ends of a Type A/B cable are different. The more-rectangular end plugs into the computer and the more-square end plugs into the Reference 600.

A suitable USB cable was included with your Reference 600+ shipment. If this cable is lost, you can replace it with a cable from your local computer retailer.

The Reference 600+ is a High Speed USB 2.0 peripheral, able to transfer data at 480 Mbits/second. If it is plugged into a computer port incapable of High Speed operation it will downgrade to USB 1.1 full-speed operation (12 Mbits/second), causing slower data-transfer.

The Reference 600+ **USB** port is compatible with Revision 1.1 and 2.0 of the USB specification. It supports the Windows® Plug-n-Play mechanism, including dynamic connect/reconnect.

The front panel **USB** LED should be green whenever a valid computer to Reference 600+ connection has been made, and both the computer and Reference 600+ are fully powered.



Thermocouple Input

The Reference 600+ has a **T/C Type K** input jack for a K-Type thermocouple. The ISO standard calls for color-coded mini-thermocouple connections. Yellow is the color assigned to K-Type thermocouples. The mating connector on your thermocouple should therefore be yellow.

Possible uses for temperature measurement in an electrochemical test include:

- Looking for a temperature rise at end-of-charge on a battery.
- Measuring ambient temperature prior to a corrosion measurement in the field.
- Measuring temperature in a cell before making a CV measurement that will be used to calculate reaction kinetics.

Gamry Instruments chose not to provide a thermocouple with the Reference 600+. There is simply too much variety in the mechanical design of thermocouple probes. Commercial thermocouples designed for measurement in air, on solid surfaces, and in immersion service are available from a variety of vendors. Make sure you get the proper type thermocouple as shown on the rear of your Reference 600+.

The Reference 600+ uses a temperature measurement IC to convert the thermocouple output to a useable voltage. It outputs a voltage that is nominally 10 mV per degree Celsius. For the K-Type thermocouple, the Analog Device AD597AR is rated for an accuracy of 4°C. The specified accuracy is only achieved when the Reference 600+ is calibrated. The scaling at the A/D converter is ± 3 V full-scale, or $\pm 300^\circ\text{C}$ full-scale.

The Reference 600+ calibration application has an optional section for thermocouple calibration. An ice-water bath and a beaker of boiling water provide convenient standards for a two-point calibration.



Caution: One side of the thermocouple is connected to the Reference 600+'s Floating Ground. An improper connection to the thermocouple input can compromise the Reference 600+'s ability to float, and invalidate data collected on earth-grounded cells. A connection to a non-insulated thermocouple immersed in your electrochemical cell can also cause erroneous readings.

Misc. I/O Connector

The **Misc.** (Miscellaneous) **I/O** connector is a multipurpose connector. It contains both digital and analog signals used to connect external devices to the Reference 600+.

All of its signals are isolated from both earth ground and the Reference 600+'s Floating Ground. The device connected to this connector establishes a ground reference. This isolation allows the **Misc. I/O** connector to be connected to earth-grounded apparatus, without compromising the Reference 600+'s ground isolation.

A full description of this connector can be found in Appendix C of this manual. This appendix includes details such as connector pin-out, output and input voltage levels, and full signal descriptions.

The following list is a short description of the signals in the **Misc. I/O** Connector and their uses:

- Sync Out and Sync In signal allow two or more Reference 600+ potentiostats to use one data-acquisition clock.
- Four digital outputs can be used to turn on external devices under control of an Explain experimental control script.
- Some of Gamry applications assign three of the digital outputs to control stirring, flow of de-aeration gas, and formation of mercury drops on a mercury-drop electrode.
- Four digital inputs that can be read in an Explain experimental control script.



- A 12-bit D/A converter used to set "continuously variable" settings, such as electrode-rotation rate on a rotating-disk electrode.
- A 5 V isolated power supply that can provide up to 50 mA of current for external circuitry.



Caution: Floating operation of Reference 600+ can be compromised by improper connections to the **Misc. I/O** Connector. We do not recommend use of standard 15-pin shielded cables with this connector. Custom cables with the shield connected to pin 6 of the D-connector are preferred.

I Monitor BNC

The **I Monitor** BNC connector is the output of the Reference 600+'s current measurement circuit. With the exception of the filtering described below, it is the raw signal. It is high bandwidth on the less-sensitive

current ranges. The effective bandwidth of the current signal falls as you reach the nA and pA current ranges. IE Stability capacitors further slow the response.

The outer shell of this BNC connector is connected to the Reference 600+'s floating ground.



Caution: The shell of the **I Monitor** BNC is connected to the Reference 600+'s Floating Ground. Connection of this BNC to a piece of earth-ground-referenced equipment can compromise the Reference 600+'s ability to float, and invalidate data collected on earth-grounded cells.

Scaling on this signal is ± 3 V for \pm the nominal full-scale current on the selected current range. Cathodic currents cause a positive output voltage. If the software is auto-ranging the current-range selection, this signal is discontinuous at each change of range.

The **I Monitor** BNC connector is lightly filtered using an RLC circuit. It has a bandwidth of approximately 3 MHz when connected to a high-impedance input. This bandwidth is further reduced if a coaxial cable is connected to the BNC. Its output impedance is approximately 200 Ω in parallel with 220 pF.

E Monitor BNC

The **E Monitor** BNC connector is the output of the Reference 600+'s differential electrometer circuit. With the exception of the filtering described below, it is a buffered representation of the voltage difference between the white and blue cell cable leads. It has very high bandwidth.

The outer shell of the BNC connector is connected to the Reference 600+'s floating ground.



Caution: The shell of the **E Monitor** BNC is connected to the Reference 600+'s Floating Ground. Connection of this BNC to a piece of earth-ground-referenced equipment can compromise the Reference 600+'s ability to float, and invalidate data collected on earth-grounded cells.

The **E Monitor** BNC connector is lightly filtered using an RLC circuit. It has a bandwidth of approximately 3 MHz when connected to a high-impedance input. This bandwidth is further reduced



if a coaxial cable is connected to the BNC. Its output impedance is approximately 200 Ω in parallel with 220 pF.

Ext. Sig.In BNC

The **Ext. Sig.In** BNC connector allows you to add a voltage to the Reference 600's Signal Generator. This signal is summed with the other signal-generator sources, including the IR DAC, the Scan DAC, and the DDS output.

The outer shell of the BNC is connected to the Reference 600+'s floating ground.



Caution: The shell of the **Ext. Sig.In** BNC is connected to the Reference 600+'s Floating Ground. Connection of this BNC to a piece of earth-ground-referenced equipment can compromise the Reference 600+'s ability to float, and invalidate data collected on earth-grounded cells.

The signal generator output is usually directly connected to the potentiostat's input. When the cell is turned on in potentiostat mode, the feedback is such that a negative-signal generator output creates a positive differential electrometer signal, which corresponds to a negative working electrode versus reference electrode voltage.

The polarity of the **Ext. Sig.In** signal is inverted at the signal generator's output. As described above, a negative input signal on this BNC creates a positive change in the working electrode versus reference electrode voltage. The input impedance of this signal is 3 k Ω in parallel with 15 pF.

Sig. Gen.Out BNC

The **Sig. Gen.Out** BNC connector allows you to monitor the "signal generator" signal being sent from the Reference 600+'s controller board to the potentiostat board. This signal has a high bandwidth. The signal output range is -15 V to +15 V.

The outer shell of the BNC is connected to the Reference 600+'s floating ground.





Caution: The shell of the **Sig. Gen.Out** BNC is connected to the Reference 600+'s Floating Ground. Connection of this BNC to a piece of earth-ground-referenced equipment can compromise the Reference 600+'s ability to float, and invalidate data collected on earth-grounded cells.

The **Sig. Gen.Out** BNC connector is lightly filtered using an RLC circuit. It has a bandwidth of approximately 3 MHz when connected to a high-impedance input. This bandwidth is further reduced if a coaxial cable is connected to the BNC. Its output impedance is approximately 200 Ω in parallel with 220 pF.

Aux. In BNC

The **Aux. In** BNC connector allows you to measure a voltage from outside the Reference 600+ using the Reference 600+'s internal A/D. The scaling is ± 3 V input equals $\pm 30\,000$ A/D counts. This is a resolution of 100 μV per bit. Results are reported in volts. The input is differential (see Appendix D).

The allowed input voltage range is -24 V to $+24$ V.



Caution: Voltages outside the range ± 24 V could damage the Reference 600+ circuitry.

Consult Appendix D for additional information concerning this connector.



Chapter 7: Stability in Potentiostat Mode

Capacitive Cells and Stability

All potentiostats can become unstable when connected to capacitive cells. The capacitive cell adds phase-shift to the potentiostat's feedback signal (which is already phase-shifted). The additional phase-shift can convert the potentiostat's power amplifier into a power oscillator.

To make matters worse, almost all electrochemical cells are capacitive because an electrical double-layer forms next to a conductor immersed in a solution.

Potentiostat oscillation is an AC phenomenon. However, it can affect both AC and DC measurements. Oscillation often causes excessive noise or sharp DC-shifts in the system's graphical output. The Reference 600+ Potentiostat can be stable on less-sensitive current ranges and unstable on more-sensitive current ranges. Whenever you see sharp breaks in the current recorded on the system, you should suspect oscillation.

The Reference 600+ has been tested for stability with cell capacitors between 10 pF and 0.1 F. In all but its fastest control-amplifier speed setting, it is stable on any capacitor in this range—as long as the impedance in the reference-electrode lead does not exceed 20 k Ω . With reference-electrode impedances greater than 20 k Ω , the Reference 600+ may oscillate. The RC filter formed by the reference-electrode impedance and the reference terminal's input capacitance filters out the high-frequency feedback needed for potentiostat stability.

Longer cell cables make the problem worse by increasing the reference terminal's effective input capacitance.

Even when the system is stable (not oscillating), it may exhibit ringing whenever there is a voltage step applied to the cell. The Reference 600+'s D/A converters routinely apply steps, even when making a pseudo-linear ramp. While this ringing is not a problem with slow DC measurements, it can interfere with faster measurements. The steps taken to eliminate potentiostat oscillation also help to minimize ringing.

Improving Potentiostat Stability

There are a number of things that you can do to improve an unstable or marginally-stable Reference 600+ potentiostat/cell system. This list is not in any particular order: any or all of these steps may help.

- Slow down the potentiostat. The Reference 600+ has five control-amplifier speed settings, which can be selected in software. Slower settings are generally more stable.
- Increase the Reference 600+'s I/E stability setting. The Reference 600+ includes three capacitors that can be connected in parallel with its I/E converter resistors. These capacitors are connected to relays that are controlled by software. Contact your local Gamry Instruments' representative for more information concerning changes in these settings.
- Lower the reference-electrode impedance. Make sure that you don't have a clogged reference electrode junction. Avoid asbestos-fiber reference electrodes and double-junction electrodes. Avoid small-diameter Luggin capillaries. If you do have a Luggin capillary, make sure that the capillary's contents are as conductive as possible.
- Add a capacitively-coupled low-impedance reference element in parallel with your existing reference electrode. The classic fast combination reference electrode is a platinum wire and a junction-isolated SCE. See Figure 7-1. The capacitor ensures that DC potential comes from the SCE, and AC potential from the platinum wire. The capacitor value is generally determined by trial and error.

Figure 7-1
Fast Combination Reference Electrode

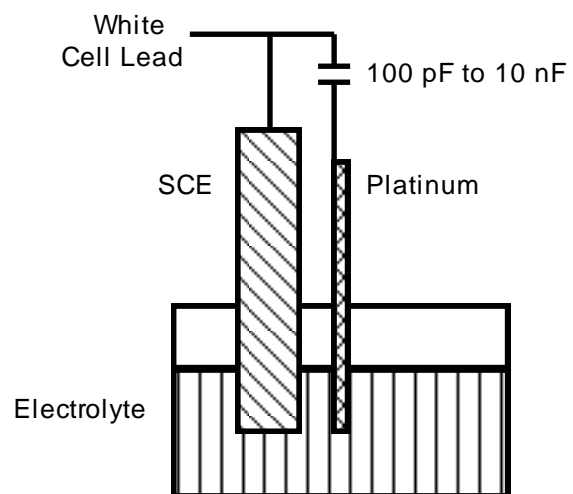

- Provide a high-frequency shunt around the cell. A small capacitor between the red and white cell leads allows high-frequency feedback to bypass the cell. See Figure 7-2. The capacitor value is generally determined by trial and error. One nF (1000 pF) is a good starting point.

In a sense, this is another form of an AC-coupled low-impedance reference electrode. The counter electrode is the low-impedance electrode, eliminating the need for an additional electrode in the solution.

Figure 7-2
High-Frequency Shunt

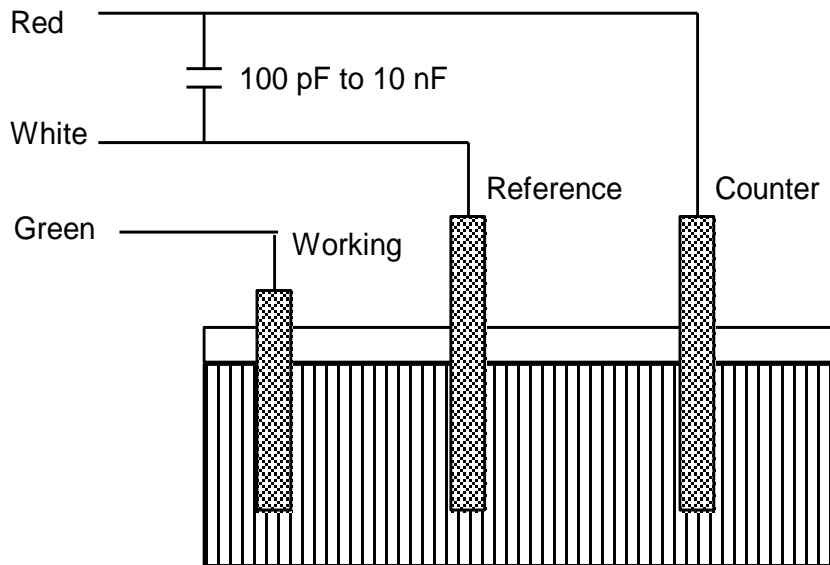

- Add resistance to the counter electrode lead. See Figure 7-3. This change lowers the effective bandwidth of the control amplifier. As a rule of thumb, select the resistor to give 1 V of drop at the highest current expected in the test being run. For example, if you expect your highest current to be around 1 mA, you can add a 1 k Ω resistor.

This resistor has no effect on the DC accuracy of the potentiostat. It can create problems in high-speed experiments such as fast CV scans or EIS, which need high bandwidth.

Figure 7-3
Resistor Added for Stability

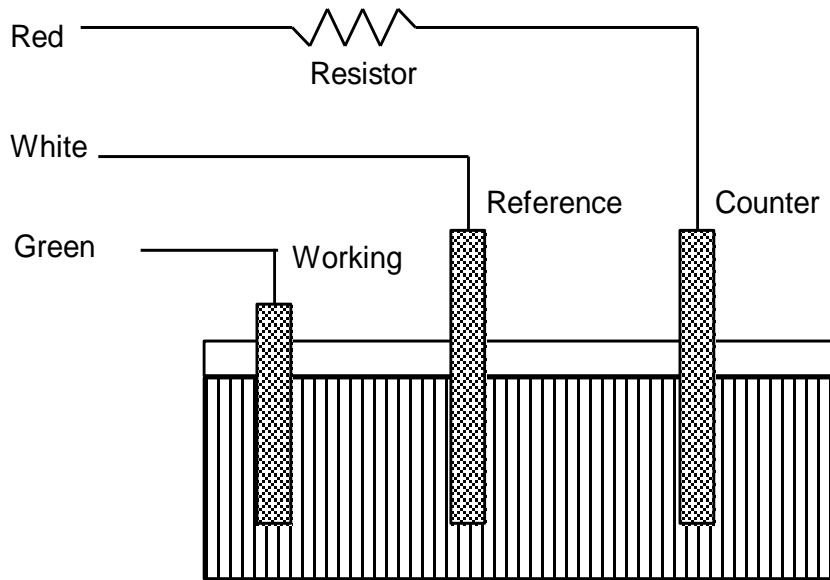

Chapter 8: Measurement of Small Signals

Overview

The Reference 600+ is a very sensitive scientific instrument. It can theoretically resolve current changes as small as 1 femtoampere (1×10^{-15} A). To place this current in perspective, 1 fA represents the flow of about 6000 electrons per second!

The small currents measured by the Reference 600+ place demands on the instrument, the cell, the cables and the experimenter. Many of the techniques used in higher current electrochemistry must be modified when used to measure pA currents. In many cases, the basic physics of the measurement must be considered.

This chapter discusses the limiting factors controlling low-current measurements. It includes hints on cell and system design. The emphasis is on EIS (Electrochemical Impedance Spectroscopy), a highly demanding application for the Reference 600+.

Measurement System Model and Physical Limitations

To get a feel for the physical limits implied by very sensitive current measurements, consider the equivalent circuit shown in Figure 8-1. We are attempting to measure the cell impedance given by Z_{cell} .

This model is valid for analysis purposes even though the real Reference 600+ circuit topology differs significantly.

In Figure 8-1:

E_S	ideal signal source
Z_{cell}	unknown cell impedance
I_{cell}	“real” cell current
R_m	current measurement circuit’s current-measurement resistance
R_{shunt}	unwanted resistance across the cell
C_{shunt}	unwanted capacitance across the cell
C_{in}	current-measurement circuit’s stray input capacitance
R_{in}	current-measurement circuit’s stray input resistance
I_{in}	measurement circuit’s input current

In the ideal current-measurement circuit, R_{in} is infinite while C_{in} and I_{in} are zero. All of the cell current, I_{cell} , flows through R_m .

With an ideal cell and voltage source, R_{shunt} is infinite and C_{shunt} is zero. All the current flowing into the current measurement circuit is due to Z_{cell} .

The voltage developed across R_m is measured by the meter as V_m . Given the idealities discussed above, use Kirchoff’s and Ohm’s laws to calculate Z_{cell} :

$$Z_{\text{cell}} = E_S \times R_m / V_m$$

Figure 8-1
Equivalent Measurement Circuit

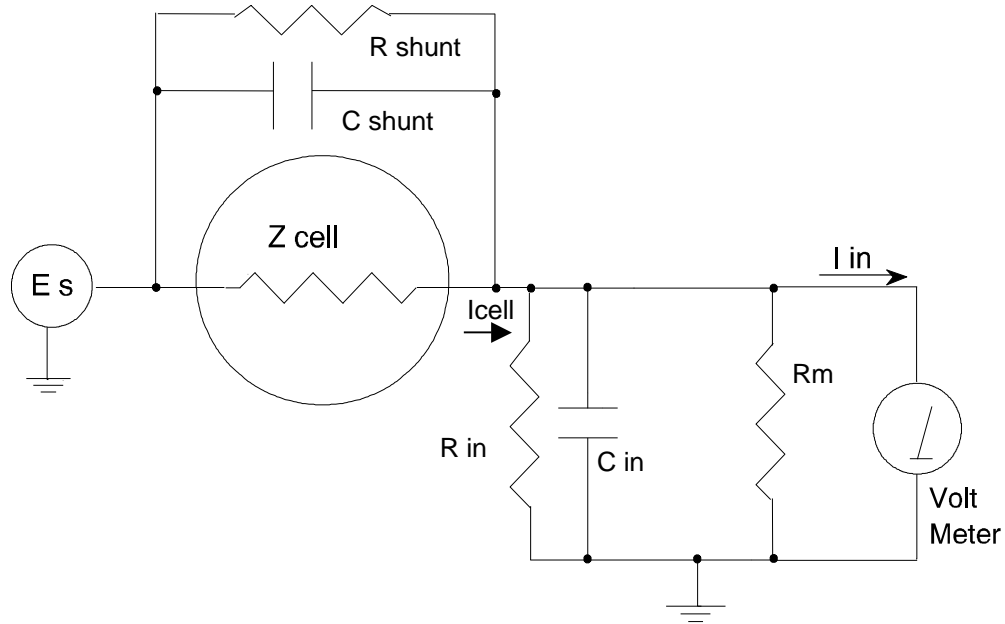

Unfortunately technology limits high-impedance measurements because:

- Current measurement circuits always have non-zero input capacitance, i.e., $C_{in} > 0$.
- Infinite R_{in} cannot be achieved with real circuits and materials.
- Amplifiers used in the meter have input currents, i.e., $I_{in} > 0$.
- The cell and the potentiostat create both a non-zero C_{shunt} and a finite R_{shunt} .

Additionally, basic physics limits high-impedance measurements via Johnson noise, which is the inherent noise in a resistance.

Johnson Noise in Z_{cell}

Johnson noise across a resistor represents a fundamental physical limitation. Resistors, regardless of composition, demonstrate a minimum noise for both current and voltage, per the following equations:

$$E = (4kTR \delta F)^{1/2}$$

$$I = (4kT \delta F / R)^{1/2}$$

where:

k = Boltzman's constant 1.38×10^{-23} J/K

T = temperature in K

δF = noise bandwidth in Hz

R = resistance in Ω .

For purposes of approximation, the noise bandwidth, δF , is equal to the measurement frequency. Assume a $10^{11} \Omega$ resistor as Z_{cell} . At 300 K and a measurement frequency of 1 Hz this gives a voltage noise of 41 μV rms. The peak-to-peak noise is about five times the rms noise. Under these conditions, you can make a voltage measurement of ± 10 mV across Z_{cell} with an error of about $\pm 0.4\%$. Fortunately, an AC

measurement can reduce the bandwidth by integrating the measured value at the expense of additional measurement time. With a noise bandwidth of 1 mHz, the voltage noise falls to about 1.3 μV rms.

Current noise on the same resistor under the same conditions is 0.41 fA. To place this number in perspective, a ± 10 mV signal across this same resistor will generate a current of ± 100 fA, or again an error of up to $\pm 0.4\%$. Reducing the bandwidth helps. At a noise bandwidth of 1 mHz, the current noise falls to 0.013 fA.

With E_s at 10 mV, an EIS system that measures $10^{11} \Omega$ at 1 Hz is about $2^{1/2}$ decades away from the Johnson-noise limits. At 10 Hz, the system is close enough to the Johnson-noise limits to make accurate measurements impossible. Between these limits, readings get progressively less accurate as the frequency increases.

In practice, EIS measurements usually cannot be made at high-enough frequencies that Johnson noise is the dominant noise source. If Johnson noise is a problem, averaging reduces the noise bandwidth, thereby reducing the noise at a cost of lengthening the experiment.

Finite Input Capacitance

C_{in} in Figure 8-1 represents unavoidable capacitances that always arise in real circuits. C_{in} shunts R_m , draining off higher-frequency signals, limiting the bandwidth that can be achieved for a given value of R_m . This calculation shows at which frequencies the effect becomes significant. The frequency-limit of a current measurement (defined by the frequency where the phase error hits 45°) can be calculated from:

$$f_{RC} = 1/(2\pi f R_m C_{in})$$

Decreasing R_m increases this frequency. However, large R_m values are desirable to minimize the effects of voltage drift and voltage noise in the I/E converter's amplifiers.

A reasonable value for C_{in} in a practical, computer-controllable, low-current measurement circuit is 20 pF. For a 6 nA full-scale current range, a practical estimate for R_m is $10^7 \Omega$.

$$f_{RC} = 1/6.28 (1 \times 10^7)(2 \times 10^{-12}) \approx 8000 \text{ Hz}$$

In general, stay two decades below f_{RC} to keep phase-shift below one degree. The uncorrected upper frequency-limit on a 6 nA range is therefore around 80 Hz.

You can measure higher frequencies using the higher-current ranges (i.e., lower-impedance ranges) but this reduces the total available signal below the resolution limits of the "voltmeter". This exercise forms one basis to the statement that high-frequency and high-impedance measurements are mutually exclusive.

You can use software correction of the measured response to improve the useable bandwidth, but not by more than an order of magnitude in frequency.

Leakage Currents and Input Impedance

In Figure 8-1, both R_{in} and I_{in} affect the accuracy of current measurements. The magnitude error caused by R_{in} is calculated via:

$$\text{Error} = 1 - R_{in}/(R_m + R_{in})$$

For an R_m of $10^7 \Omega$, an error $< 1\%$ demands that R_{in} must be greater than $10^9 \Omega$. PC-board leakage, relay leakage, and measurement-device characteristics lower R_{in} below the desired value of infinity.

A similar problem is the finite input-leakage current I_{in} into the voltage-measuring circuit. It can be leakage directly into the input of the voltage meter, or leakage from a voltage source (such as a power supply) through an insulation resistance into the input. If an insulator connected to the input has a resistance of $10^{12} \Omega$ between +15 V and the input, the leakage current is 15 pA. Fortunately, most sources of leakage

current are DC and can be tuned out in impedance measurements. As a general rule, the DC leakage should not exceed the measured AC signal by more than a factor of 10.

The Reference 600+ uses an input amplifier with an input current of around 1 pA. Other circuit components may also contribute leakage currents. You therefore cannot make absolute current measurements of very low pA currents with the Reference 600+. In practice, the input current is approximately constant, so current differences or AC current levels of less than one pA can often be measured.

Voltage Noise and DC Measurements

Often the current signal measured by a potentiostat shows noise that is not the fault of the current-measurement circuits. This is especially true when you are making DC measurements. The cause of the current noise is noise in the voltage applied to the cell.

Assume that you have a working electrode with a capacitance of 40 μF . This could be represented by a 1 cm^2 polished bare metal immersed in an electrolyte solution. A rough estimate of the capacitance of the electrical double-layer formed by a metal/electrolyte interface is 20 $\mu\text{F}/\text{cm}^2$. The area is the microscopic area of the surface, which is larger than the macroscopic geometric area, because even a polished surface is rough. The impedance of this 40 μF electrode, assuming ideal capacitive behavior, is given by:

$$Z = 1/j\omega C$$

At 60 Hz, the impedance magnitude is about 66 Ω .

Apply an ideal DC potential across this ideal capacitor and you get no DC current.

Unfortunately, all potentiostats have noise in the applied voltage. This noise comes from the instrument itself and from external sources. In many cases, the predominant noise frequency is the AC power-line (mains) frequency.

Assume a realistic noise voltage, V_n , of 10 μV (this is lower than the noise-level of most commercial potentiostats). Further, assume that this noise voltage is at the North American power-line (mains) frequency of 60 Hz. The noise voltage creates a current across the cell capacitance:

$$I = V_n/Z \approx 10 \times 10^{-6}/66 \approx 150 \text{ nA}$$

This rather large noise current prevents accurate DC current measurement in the low nA or pA ranges.

In an EIS measurement, you apply an AC excitation voltage that is much bigger than the typical noise voltage, so this is not a significant problem.

Shunt Resistance and Capacitance

Non-ideal shunt resistance and capacitance arise in both the cell and the potentiostat. Both can cause significant measurement errors.

Parallel metal surfaces form a capacitor. The capacitance rises as the metal's area increases and as the separation distance between the metals decreases.

Wire and electrode placement have a large effect on shunt capacitance. If the clip leads connecting to the working and reference electrodes are close together, they can form a significant shunt capacitor. Values of 1 to 10 pF are common. This shunt capacitance cannot be distinguished from "real" capacitance in the

cell. If you are measuring a paint film with a 100 pF capacitance, 5 pF of shunt capacitance is a very significant error.

Shunt resistance in the cell arises because of imperfect insulators. No material is a perfect insulator (infinite resistance). Even PTFE, which is one of the best insulators known, has a bulk resistivity of about $10^{12} \Omega \cdot \text{m}$. Worse yet, surface contamination often lowers the effective resistivity of good insulators. Water films can be a real problem, especially on glass.

Shunt capacitance and resistance also occur in the potentiostat itself. The Reference 600+ Potentiostat mode specifications in Appendix A contain equivalent values for the potentiostat's R_{shunt} and C_{shunt} . These values can be measured by an impedance measurement with no cell.

In most cases, the cell's shunt resistance and capacitance errors are larger than those from the potentiostat.

Hints for System and Cell Design

The following hints may prove helpful.

Faraday Shield

A Faraday shield surrounding your cell is **mandatory** for very low-level measurements. It reduces both current noise picked up directly on the working electrode and voltage noise picked up by the reference electrode.

A Faraday shield is a conductive enclosure that surrounds the cell. The shield can be constructed from sheet metal, fine-mesh wire screen, or even conductive paint on plastic. It must be continuous and completely surround the cell. Don't forget the areas above and below the cell. All parts of the shield must be electrically connected. You will need an opening in the shield large enough to allow a cell cable to enter the shield.

The shield **must be electrically connected** to the Reference 600+'s floating-ground terminal.

An additional connection of both the shield and the Reference 600+ floating ground to an earth ground may also prove helpful.



Only connect the Reference 600+ ground to earth ground if all conductive cell components are well-isolated from earth ground. A glass cell is usually well isolated. An autoclave is generally not well isolated.

Avoid External Noise Sources

Try to keep your system away from electrical noise sources. Some of the worst are:

- Fluorescent lights
- Motors
- Radio transmitters
- Computers and computer monitors

Try to avoid AC-powered or computerized apparatus within your Faraday shield.

Cell Cable Length and Construction

The Reference 600+ is shipped with a 60 cm shielded cell cable. We also offer extended length cables and unshielded cables as options at extra cost.

Cell cables longer than 1 meter **will** result in degraded instrument performance. Increased noise and decreased stability both can occur. However, with most cells, the instrument will work acceptably with an extended cell cable, so our advice is to try it. As a rule, do not attempt to use current-interrupt *IR*-compensation with cell cables longer than 5 m.

We do not recommend that you use the Reference 600+ with any cables not supplied by Gamry Instruments. The Reference 600+ cable is not a simple cable like a typical computer cable. The Reference 600+ cable includes a number of individually shielded wires contained within an overall shield. We pay careful attention to issues such as shield isolation, isolation resistance, and capacitance.

If you do need a special cable, contact us with your requirements.

Lead Placement

Many experiments with the Reference 600+ involve cells with small capacitances, the value of which may be important.

In these cases, the capacitance between the Reference 600+'s cell leads can result in an error. The Reference 600+ alligator clips can have 10 pF or more of mutual capacitance if they are run alongside each other.

If you wish to avoid excessive capacitance:

- Place the leads as far apart as possible. Pay special attention to physical separation between the working electrode/working sense leads and the counter/counter sense/reference electrode leads.
- Have the leads approach the cell from different directions.
- Remove the alligator clips from the leads. In extreme cases you can replace the banana plugs and pin jack with smaller connectors. If you do so, be careful not to compromise the isolation between the center conductor and the shield.

The cell leads must not be moved during an experiment measuring small currents. Both microphonic and triboelectric effects can create spurious results when the cell cables are moved.

Cell Construction

If you need to measure small currents or high impedances, make sure that your cell construction does not limit your response.

A cell where the resistance between the electrodes is only $10^{10} \Omega$ cannot be used to measure $10^{13} \Omega$ impedances. In general, glass and PTFE are the preferred construction materials for cells. Even glass may be a problem when it is wet.

You also must consider C_{shunt} . Make the "inactive" portion of your electrodes as small as possible. Avoid placing electrodes close together or parallel with each other if you are measuring high impedances.

Reference Electrode

Keep your reference electrode impedance as low as possible. High-impedance reference electrodes can cause potentiostat instability and excessive pickup of voltage-noise.

Try to avoid:

- Narrow-bore or glass-frit-tipped Luggin capillaries.
- Poorly conductive solutions, especially in Luggin capillaries.
- Asbestos-thread and double-junction reference electrodes.

Reference electrodes often develop high impedances as they are used. Anything that can clog the isolation frit can raise the electrode impedance. Avoid using saturated KCl-based references in perchlorate-ion solutions.

Instrument Settings

There are several things to remember in setting up a very sensitive experiment.

- In EIS, use the largest practical excitation. Don't use a 10 mV excitation on a coated specimen that can handle 100 mV without damage.
- Avoid potentials where large DC currents flow. You cannot measure 1 pA of AC current on top of 1 mA of DC current.

EIS Speed

In EIS, do not expect the Reference 600+ to measure $10^{13} \Omega$ impedances at 1 kHz. Many of the factors listed above limit the performance.

As a rule of thumb, the product of impedance, Z , times frequency, f , should be less than $10^9 \Omega \cdot \text{Hz}$ for good EIS measurements with a Reference 600+.

$$Z \cdot f < 10^9 \Omega \cdot \text{Hz}$$

Ancillary Apparatus

Do not use the Reference 600+ with ancillary apparatus connected directly to any of the cell leads. Ammeters and voltmeters, regardless of their specifications, almost always create problems when connected to the Reference 600+ cell leads.

Floating Operation

The Reference 600+ is capable of operation with cells where one of the electrodes or a cell surface is at earth ground. Examples of earth-grounded cells include: autoclaves, stress apparatus, pipelines, storage tanks and battleships. The Reference 600+'s internal ground is allowed to float with respect to earth ground when it works with these cells, hence the name "floating operation".

Instrument performance can be substantially degraded when the Reference 600+ is operated in a floating mode. The instrument specifications only apply on isolated cells with the Reference 600+ earth-ground referenced (not floating).

Special precautions must be taken with the cell connections when the Reference 600+ must float. Make sure that all the cell connections are isolated from earth ground. In this case, you must disconnect the chassis-ground terminal of the Reference 600+ from earth ground.

Finally, ancillary apparatus connected to the Reference 600+ must be isolated. External voltmeters, ammeters, FRAs, etc. must be isolated. This includes devices connected to the monitor connectors located on the Reference 600+ rear panel.

Appendix A: Reference 600+ Specifications

All specifications are at an ambient temperature of 25°C, with the Reference 600+ powered using the external power supply shipped with the unit, a standard shielded 60 cm cell cable, and the cell enclosed in a Faraday shield. All specifications are after software calibration.

A numbered note qualifies many of the specifications. Many of these notes describe the method used to measure a specification. The notes are found at the end of this appendix.

All specifications are subject to change without notice.

Control Amplifier

Compliance Voltage	Min	±22	V	Note 1
Output Current	Min	±600	mA	Note 2
Unity Gain Bandwidth	Typ	980, 260, 40, 4.0, 0.4	kHz	Notes 3, 4
Slew Rate	Typ	10, 4.5, 0.6, 0.06, 0.006	V/μs	Notes 3, 4

Differential Electrometer

Max Input Voltage	Min	±9	V	Note 5
Input Current	Max	10	pA	Notes 5, 6
Input Resistance Differential (between inputs) Common Mode (input to ground)	Typ	100 1	TΩ	Note 7
Input Capacitance Differential (between inputs) Common Mode (input to ground)	Typ	0.2 12	pf	Note 7
Bandwidth (–3 dB)	Min	15	MHz	Note 7
CMMR DC to 100 kHz 100 kHz to 1 MHz	Min	80 60		Note 8

Voltage Measurement

A/D Full Scale Ranges	Typ	±12.0, ±3.0	V	Note 9
Resolution	Typ	400, 100	μV/bit	
Zero Offset Error	Max	1	mV	Note 10
Gain Error	Max	0.2	%	Note 10
Offset Range	Typ	±10	V	
Post- Offset Gain	Typ	1x, 10x, 100x		

Current to Voltage Converter

Maximum Full Scale Range		600	mA	Note 11
Minimum Full Scale Range		60 600 (after $\times 100$ gain)	pA fA	Note 11
Voltage across R_m	Typ	120	mV at full scale	Note 12
Output Voltage (at BNC and ADC in)	Typ	3.0	V full scale	
Input Offset Current	Max	10	pA	Note 13
Range Zero Offset	Max	0.05	% of range	Note 13
Gain Tolerance 600 mA to 6 nA ranges 600 pA range 60 pA	Max	0.2 0.75 1.5	% of reading	Note 13
Zero drift	Typ	0.03	% FS/ $^{\circ}$ C	Note 14
Bandwidth 600 mA to 600 μ A ranges 60 μ A range 6 μ A range	Typ	> 10 > 1.5 > 0.15	MHz	Note 15

Current Measurement

Resolution	Typ	0.00333...	% FS /bit	
Offset Range	Typ	± 100	% of range	
Post- Offset Gain	Typ	1 \times , 10 \times , 100 \times		
Accuracy	Typ	Dominated by current-to-voltage error (see above)		

Potentiostatic Mode

Applied Voltage Range	Min	± 11	V	Notes 5, 6
Accuracy DC zero offset Gain	Max	1 0.2	mV % setting	Note 16
DC Bias	Typ	± 8	V	
Scan DAC ranges	Typ	± 6.4 , ± 1.6 , ± 0.4	V	
Drift	Max	< 20	μ V/ $^{\circ}$ C	Note 17
Noise and Ripple 1 Hz to 1 kHz 1 Hz to 200 kHz	Typ	10 20	μ V rms	Note 18

Galvanostatic Mode

Maximum Full Scale Current		±600	mA	Note 11
Minimum Full Scale Current		±60	pA	Note 11
Accuracy		Dominated by current-to-voltage converter accuracy shown above		
Sig Gen Voltage for Full Scale Current		±3.0	V	

Auxiliary A/D Input (see Appendix D)

Range (differential)	Typ	±3	V	
Input voltage range (either input)	Max	±3.6	V	
Gain Error	Max	0.2	%	
Input Impedance a) as shipped b) re-jumpered for high-Z input	Typ	100 10	kΩ GΩ	Note 19

Auxiliary D/A Output

Range	Typ	0 to 4.096	V	
Resolution	Typ	1	mV	

Environmental

Operating Temperature Range		0 to 45	°C	
Relative Humidity	Max	90 (non-condensing)	%	
Storage and Shipping Temperature		-25 to 75	°C	
Maximum Shipping acceleration		30	g	

General

Power Input Voltage	Range	22 to 26	volts	
Power	Max	50	W	
Leakage Current (floating, earthed Working Electrode)		± 1 nA		Note 20
Dimensions	Max	10 × 20 × 30	cm	Note 21
Weight	Max	2.5	kg	Note 21
Dimensions of External Power Adapter	Max	7.5 × 3.5 × 15	cm	Note 22
Weight of External Power Adapter	Max	400	g	Note 22

NOTES:

1. Measured in galvanostatic mode with a high-power 200 Ω load connected from counter electrode lead to the working electrode lead. The compliance voltage is measured using an external voltmeter across the 200 Ω load. Under these conditions, the output current is approximately 115 mA.
2. Measured with a precision 4-terminal 2 Ω load, in potentiostatic mode.
3. Unity-gain bandwidth and slew rate are correlated. Each has five settings, with the highest slew-rate occurring at the highest bandwidth, down to the lowest slew-rate occurring at lowest bandwidth. Both are measured with 20 k Ω between counter and reference, and 100 Ω between the reference and the working and working sense leads.
4. Measured with an external function generator connected to the **Ext. Sig.In** BNC.
5. The Differential Electrometer Amplifiers are Analog Devices AD8065 op amps specially selected for low V_{os} drift versus temperature. These amps have a dual-input stage, with a JFET input over most of their input range and a bipolar transistor input at input voltages greater than +9.5 V. They are only a high-impedance buffer from -12 V to +9.5 V, though they are a unity-gain buffer over their whole input-voltage range.
6. The input current of the JFET inputs on the AD8065s is less than 6 pA. When the bipolar input is operative, the input current can be in the μ A range. The specified current is only applicable at voltages of 2 V or less.
7. The differential impedance is measured between the Reference and Work Sense inputs. This is the impedance you measure when you record the EIS spectrum of an infinite impedance cell.

There is also a common-mode resistance and capacitance associated with the differential electrometer inputs. These values tell you how much the electrometer response is modified by a resistance in series with the source.

8. The bandwidth is for a sine-wave source with a 50 Ω output impedance driving either input. The bandwidth is well in excess of this specification, which is limited by the measurement equipment used in testing the Reference 600+.
9. CMRR is common-mode rejection ratio. It specifies the ability of the differential electrometer to reject signals connected to both inputs. The CMRR is measured driving both inputs with a sine-wave source with a 50 Ω output impedance, and measuring the error as a function of frequency. Resistance in either input will cause a loss of CMRR.
10. Voltage measurement is actually performed with a ± 3 V signal input to the ADC signal chain. A $\div 4$ attenuator divides down higher-voltage electrometer outputs so they fit into a ± 3 V input, thus making a ± 12 V full-scale range.

11. The total error in a voltage measurement is:

$$\text{Error} = \text{Zero Offset Error} + \text{Gain Error} \times \text{Voltage}$$

For a 1 V signal the error can be as high as 3 mV.

12. There are 11 hardware current ranges, separated in sensitivity by decades. The ranges are 60 pA, 600 pA, 6 nA, ... 60 mA, 600 mA full-scale. The $\times 10$ and $\times 100$ gains add two virtual ranges of 6 pA and 600 fA full scale.
13. The voltage across the current measurement resistor, R_m , is as shown. Slightly higher voltages may be seen at the working electrode terminal on the cell cable, because the cable has both resistive and inductive impedance.
14. The total error in a current measurement is:

$$\text{Error} = \text{Input Current Offset} + \text{Range Zero Offset} \times \text{FS Current} + \text{Gain Tolerance} \times \text{Measured Current}$$

For small currents (pA) the first term is usually dominant.

For large currents (μA), the first term can usually be ignored.

The units for the error are ampères.

15. Drift can be approximated by simple drift in the Range Zero Error. In reality all three terms in the equation above can have drift.
16. The current-to-voltage converter bandwidth is a function of the current range, the cell cable, and the IEstability setting. The bandwidth can be very low on very sensitive ranges. Longer cell cables add capacitance and slow the current measurement.
17. The total error in a voltage setting is:

$$\text{Error} = \text{DC Zero Offset} + \text{Gain} \times \text{Voltage Setting}$$

For a 1 V signal the error can be as high as 3 mV.

18. This specification is guaranteed by design. It is not tested.
19. This specification is measured by applying zero voltage across a 1 Ω resistor and measuring current noise on the 600 μA scale. 1 μV of voltage noise creates a current of 1 μA . The filters in the ADC Chain for the I Signal are used to limit the bandwidths as shown in the specification.

Signal averaging via Gamry's DSP mode further reduces the measured noise.

20. See Appendix D.
21. Isolation quality has both DC factors and AC factors (predominately at the 300 kHz power-supply frequency). Only the DC leakage current is shown here. Consult Gamry's technical support for additional information.
22. Excluding external power adapter and any cables supplied with unit.
23. Excluding removable line cord.

Reference 600+ Specifications

Appendix B: Reference 600+ Cell Cable Connector

Chapter 5 **Error! Reference source not found.** describes the connections between a cell cable and an electrochemical cell. This appendix describes the other end of the cell cable.

Multiple pins assigned to the same signal are connected together on the Reference 600+'s Potentiostat board. If you need to connect this signal outside the Reference 600+, you need a wire connected to **any one** of the D-connector pins.

Table B-1
Cell Connector

Pin(s)	Signal Name	Use
1	Working Sense	Connected to the working electrode in most cases (see Chapter Error! Reference source not found.). This lead has a 403 Ω resistor in the cell end of the cable. Custom cell cables are likely to require a similar resistor.
2, 14	WS Shield	The shield for the working sense input. Driven to the same potential as Pin 1. Left open at the cell end of the cell cable.
3, 4, 15, 17	Reference Shield	The shield for the reference electrode input. Driven to the same potential as Pin 16. Left open at the cell end of the cell cable.
5, 7, 10, 11, 18, 19, 22, 24	Ground	The potentiostat's floating ground. Can be used to shield the cell if very low currents need to be measured. Also used as a shield for the counter electrode cable.
6	Counter Sense	With a Reference 600+, used to sense the potential of the counter electrode. This lead has a 403 Ω resistor in the cell end of the cable. Allows accurate ZRA mode even with significant cell current through counter lead's resistance.
8	CBL_ID1	One of four cable ID bits. Used to identify the type of cell cable attached to the unit. Pull to a logic High through a resistor. Ground to set the bit low.
9	CBL_ID2	One of four cable ID bits. Used to identify the type of cell cable attached to the unit. Pull to a logic High through a resistor. Ground to set the bit low.
12, 25	Work Shield	The shield for the working electrode input. Connected to Floating Ground. Left open at the cell end of the cell cable.
13	Working Electrode	Connected to the working electrode. The cell current flows through this pin.
16	Reference Electrode	Connected to the reference electrode in most cases (see Chapter). This lead has a 403 Ω resistor in the cell end of the cable. Custom cell cables are likely to require a similar resistor.
20	CBL_ID0	One of four cable ID bits. Used to identify the type of cell cable attached to the unit. Pull to a logic High through a resistor. Ground to set the bit low.
21	CBL_ID3	One of four cable ID bits. Used to identify the type of cell cable attached to the unit. Pull to a logic High through a resistor. Ground to set the bit low.
23	Counter Electrode	Connected to the cell's counter electrode. The cell current flows through this connection.



Designing cell cabling for a 5 MHz potentiostat is not a trivial task. Gamry Instruments does not recommend user-designed cables (except as a last resort). In many cases we can build a custom cable to meet your specific needs. We'll also be happy to discuss your cabling requirements and give you assistance if you must you design and build your own cell cable.

Appendix C: Misc. I/O Connector

The **Misc. I/O** connector contains a number of signals used to connect the Reference 600+ to external apparatus. It is the miniature 15-pin female D-shaped connector on the rear panel of the Reference 600+. Be careful: the ground pins on this connector are isolated from both the Reference 600+ floating ground and earth ground.

The metal shell of the D-connector is connected to the Reference 600's Floating Ground. Improper **Misc. I/O** connections can damage a Reference 600+ that is connected to a high-energy cell containing earth-grounded terminals.

The auxiliary analog output, derived from a D/A converter, is on this connector. The scaling is normally 1 mV per bit, for a 0 to 4.096 V full-scale range.

The pin-out of this connector is shown in Table C-1.

Table C-1
Misc. I/O Connector Pins

Pin	Name	Use
1	Analog Output High	The auxiliary output signal (DAC output).
2	Analog Output Low	The auxiliary output ground connection (ground)
3	Sync In	Used in slave mode; starts data-acquisition 2.2 k Ω input impedance
4	Sync Out	A TTL pulse output before the start of a data point 330 Ω output impedance
5	No connection	
6	Ground	Digital ground
7	Digital Out 0	A TTL-compatible digital output; 330 Ω output impedance
8	Digital Out 1	A TTL-compatible digital output; 330 Ω output impedance
9	Digital Out 2	A TTL-compatible digital output; 330 Ω output impedance
10	Digital Out 3	A TTL-compatible digital output; 330 Ω output impedance
11	Digital In 0	A TTL-compatible digital input; 2.2 k Ω input impedance
12	Digital In 1	A TTL-compatible digital input; 2.2 k Ω input impedance
13	Digital In 2	A TTL-compatible digital input; 2.2 k Ω input impedance
14	Digital In 3	A TTL-compatible digital input; 2.2 k Ω input impedance
15	+5 V	Power: 50 mA maximum current



Caution: Floating operation of the Reference 600+ can be compromised by connecting improper cables to the **Misc. I/O** Connector. We do not recommend use of standard 15-pin shielded cables with this connector. Custom cables with the shield connected to pin 6 of the D-connector are preferred.

Appendix D: Auxiliary A/D Input Characteristics

The controller board used in the Gamry Instruments Reference 600+ Potentiostat has software switches that configure the input circuitry used for the Aux A/D function.

The CMOS switches are set using a function call in an Explain script. Once the CMOS switches are set, they remain in the selected position until another script resets them. Note that the settings return to their default values on reset or Power Up of the Reference 600+.

Aux A/D Specifications

Range	± 3.276 V	
Input Impedance	100 k Ω (approx)	Low Impedance Selected
	or	
	10 G Ω (typical)	High Impedance Selected
Input Bias Current	< 10 nA	High Impedance selected
Filter Cutoff	20 Hz \pm 20%	With Low Bandwidth selected

Function Call to Set the Aux A/D BNC Characteristics

The CMOS switch is set using an Explain function call. The syntax of this call is:

```
Pstat.SetAuxBNCImpedance (Impedance)
```

The variable passed to the function is a Boolean (with a value of TRUE or FALSE).

The following definitions can be used to make a script that calls this function more readable:

```
High impedance is TRUE
Low impedance is FALSE
```

A TRUE in the Impedance variable opens the switches across J902 and J903, selecting high input impedance. A FALSE selects 100 k Ω input impedance.

Appendix E: CE Certificate



Declaration of Conformity

According to ISO/IEC Guide 22 and CEN/CENELEC EN 45014

Manufacturer's Name and Location:

Gamry Instruments
734 Louis Drive
Warminster, PA 18974
USA

This declaration is for the Gamry Instruments product models: Reference 600+ Potentiostat/Galvanostat/ZRA.

The declaration is based upon compliance with the following directives:

EMC Directive 89/336/EEC as amended by 92/31/EEC and 93/68/EEC
 Low Voltage Safety Directive 73/23/EEC as amended by 93/68/EEC

The declaration is based upon product compliance with the following standards as defined in report number R0295-000 from Ergonomics, Inc. for safety analysis and report number RSI-2772L from Radiation Sciences, Inc. for EMC test and analysis.

EMC Standards	Title	Class/ Criteria
EN 61000-4-2	EMC – Electrostatic discharge, Immunity	B
EN 61326:2002-2	EMC – Radiated Emissions	A

Low Voltage Directive Safety Standards	Title
EN 61010-1:2001	Safety requirements for electrical equipment for measurement, control and laboratory use, Part 1: General requirements.
EN 61010-2-081: 6/2003	Safety requirements for electrical equipment for measurement, control and laboratory use, Part 2 Particular requirements for automatic and semiautomatic laboratory equipment for analysis and other purposes



 Signature

September 29, 2005
 Date

Dr. Gregory A. Martinchek, PhD
 Title: President

Formal signed declaration is on file at Gamry, Inc.

Appendix E: CE Certificate

Certificate of Conformance



RADIATION SCIENCES INC.

CERTIFICATE OF CONFORMANCE



Applicant: Gamry Instruments, Inc.
734 Louis Drive
Warminster, PA 18974

Equipment Under Test: REF 600

Model No.: PC5-600

Serial Numbers: 01002 (Shielded)
01022 (Unshielded)

PO# 2205-0391
Test Report No.: RSI-2772L
Test Date(s): 11 August through 15 August 2005

RADIATION SCIENCES INC. CERTIFIES THAT: The referenced equipment was tested to the specifications as detailed below. Detailed test results can be found in the referenced test report.

<u>Emission Specification(s)</u>	<u>Test Result</u>
IEC 61326 (Radiated Emissions)	PASS
<u>Immunity Specification(s)</u>	
IEC 61326 (ElectroStatic Discharge)	PASS

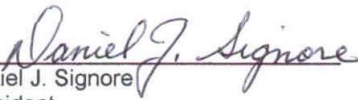
Daniel J. Signore
President
Radiation Sciences Inc.

16 Nov. 2005
Date

Radiation Sciences Inc., 3131 Detwiler Rd, Harleysville, PA. 19478 (215) 256-4133

Comprehensive Index

25 pin D	24	environmental stress	6
AC adapter	3	Ext. Sig. In BNC	51
ADC channels	15	External Signal	51
air-cooling	5	fans	5
ancillary apparatus	63	Faraday shield	40, 61
Aux A/D	75	filters	15
Aux. In BNC	52	firmware download	44
auxiliary electrode	39	floating ground	39, 47
black banana	39	floating operation	63
blue cell lead	39	fluorescent lights	61
Cable calibration	1, 33, 35	Framework software	9, 32
Cable Capacitance Calibration window	36	green cell lead	39
calcable.exp	36	ground	71
Calibrate in Framework button	33	Help system	9
calibration	16, 17, 33, 34, 35, 37, 38, 48	high frequency shunt	55
Calibration Cell	34, 35, 36, 37	hints – cell design	61
capacitive cells	53	I Monitor BNC	49
Cell Cable connector	24, 39, 43, 71	I Overload	45
CE Compliance	8	I/O connector	49
cell cable	39	input capacitance	57
ZRA connections	40	input current	57
cell construction materials	62	input impedance	57
Cell On LED	45	input leakage current	59
Chassis Ground	4, 35, 47	inspection	3
cleaning	7	installation	19
computer	10	Instrument Manager	26
computer requirements	20	Instrument Manager window	29
computers - noise	61	Johnson noise	58
contract engineering	1	Label - changing	29
Control Overload	45	lead capacitance	62
conventions		lead placement	62
notational	10	low I range dc calibration	1, 33, 37
counter electrode	39, 71	Luggin capillaries	53, 63
Counter Sense	71	materials	62
DC and AC calibration	1, 33	measurement system model	57
DC voltage	18	membrane cell connections	41
DDS	14	Misc. I/O connector	49, 73
Declaration of Conformity	77	motors	61
double insulation	3	Multiple Potentiostat Systems	25
E Monitor BNC	50	noise	60
E Overload	45	operation	6
earth ground	4, 61, 63	orange lead	39
EasyUSB	17	oscillation	53
EIS speed	63	Overload LED	45
electrical noise	61	personalization label	30
electrical transients	7	power brick	3
electrons per second	57	Power Connection	22
enclosed space	6	Power Cord	22
environmental limits	6	Power In jack	46

Power LED	43	state-machine.....	15
Power PC.....	17	static electricity.....	7
Power PC firmware	17	storage	6
power-line transient	7	support	1
Power switch.....	23, 46	telephone assistance.....	1
power-up self-test.....	23	temperature	5
radio frequency.....	7	thermocouple.....	48
radio transmitters.....	61	Universal Dummy Cell	33, 35
red cell lead	39	USB cable	23
reference electrode	39, 63, 71	USB firmware.....	17
reference electrode impedance	62	USB LED	24, 44
RFI	7	USB port.....	47
ringing.....	53	Visual Inspection	19
RoHS compliance.....	8	voltage noise	60
safety	3	Warranty.....	2
schematic.....	11	WE Shield	71
service.....	7	white cell lead.....	39
service contract	1	working electrode	39, 71
Sig. Gen. Out BNC	51	Working Sense	71
small signals.....	57	WS Shield	71
software calibration	65	ZRA	
specifications.....	65	cell connections.....	40
stability	53		