



IMX8™ Multiplexer Operator's Manual



Copyright © 2022 Gamry Instruments, Inc.
Revision 1.0
July 14, 2022
988-00087

If You Have Problems

Please visit our service and support page at www.gamry.com/service-support/. This page contains information on installation, software updates, and training. It also contains links to the latest available documentation. If you are unable to locate the information you need from our website, you can contact us via email using the link provided on our website. Alternatively, you can contact us one of the following ways:

Internet	www.gamry.com/service-support/
Telephone	(215) 682-9330 9:00 AM–5:00 PM US Eastern Standard Time (877) 367-4267 Toll-free US & Canada Only

Please have your instrument model and serial numbers available, as well as any applicable software and firmware revisions.

If you have problems in installation or use of a system containing an IMX8 Multiplexer, please call from a phone next to your computer, where you can type and read the screen while talking to us.

We will be happy to provide a reasonable level of free support for registered users of the IMX8 Multiplexer. Reasonable support includes telephone assistance covering the normal installation, use and simple customization of a computerized system containing an IMX8 Multiplexer connected to a Windows®-compatible computer.

A service contract that extends both the hardware warranty and software update period is available at an additional charge. Software updates *do not* include software enhancements offered to our customers at additional cost.

Enhancements to the IMX8 Multiplexer and Gamry's standard applications software that require significant engineering time on our part can be performed on a contract basis. Contact us with your requirements.

Limited Warranty

Gamry Instruments, Inc. warrants to the original user of this product that it shall be free of defects resulting from faulty manufacture of the product or its components for a period of two years from the original shipment date of your purchase.

Gamry Instruments, Inc. makes no warranties regarding either the satisfactory performance of the IMX8 Multiplexer including the software provided with this product or the fitness of the product for any particular purpose. The remedy for breach of this Limited Warranty shall be limited solely to repair or replacement, as determined by Gamry Instruments, Inc., and shall not include other damages.

Gamry Instruments, Inc. reserves the right to make revisions to the system at any time without incurring any obligation to install same on systems previously purchased. All system specifications are subject to change without notice.

There are no warranties which extend beyond the description herein. This warranty is in lieu of, and excludes any and all other warranties or representations, expressed, implied or statutory, including merchantability and fitness, as well as any and all other obligations or liabilities of Gamry Instruments, Inc; including but not limited to, special or consequential damages.

This Limited Warranty gives you specific legal rights and you may have others, which vary from state to state. Some states do not allow for the exclusion of incidental or consequential damages.

No person, firm or corporation is authorized to assume for Gamry Instruments, Inc., any additional obligation or liability not expressly provided herein except in writing duly executed by an officer of Gamry Instruments, Inc.

Disclaimers

Gamry Instruments, Inc. cannot guarantee that the IMX8 Multiplexer will work with all computer systems, operating systems, or third-party hardware/software.

The information in this manual has been carefully checked and is believed to be accurate as of the time of printing. However, Gamry Instruments, Inc. assumes no responsibility for errors that might appear.

Copyrights

IMX8™ Multiplexer Operator's Manual copyright © 2021–2022, Gamry Instruments, Inc., all rights reserved.

Gamry Framework copyright © 1989–2022, Gamry Instruments, Inc., all rights reserved.

Interface 1010™, Interface 5000™, Reference 600+™, Reference 620™, Reference 3000™, Reference 3000AE™, Reference 30K™, LPI1010™, eQCM 10M™, ECM8™, Gamry Framework™, Faraday Shield™, and Gamry™ are trademarks of Gamry Instruments, Inc.

Windows® is a registered trademark of Microsoft Corporation.

No part of this document may be copied or reproduced in any form without the prior written consent of Gamry Instruments, Inc.

Table of Contents

If You Have Problems	3
Limited Warranty.....	3
Disclaimers	4
Copyrights	4
Table of Contents.....	5
Chapter 1: Safety Considerations	7
Inspection	7
Product Safety.....	7
AC Mains Connection to the Power Brick.....	8
Grounding in the IMX8 Multiplexer	8
Functional Grounding and Product Safety.....	9
Temperature and Ventilation.....	10
Defects and Abnormal Stresses	10
Environmental Limits.....	10
Cleaning	11
Service.....	11
RF Warning.....	11
Electrical Transient Sensitivity	11
CE Compliance	12
RoHS Compliance.....	12
Chapter 2: Introduction	13
About this Manual.....	13
About the IMX8 Multiplexer	13
Operation Overview	13
Keyword Definitions.....	15
Switching and Inactive Cell Control	15
Notational Conventions.....	17
Chapter 3: Installation.....	19
Initial Visual Inspection	19
Physical Location	19
Quick-start Guide for System Installation	20
Connection to Gamry Instruments Reference 600+ or 620 and Interface 1000 or 1010 potentiostats	20
Connection to a Third-party Potentiostat/Galvanostat.....	20
Cell Cable Installation.....	20
Computer Requirements.....	21
Software Installation	21
Reboot your Computer after Software Installation	21
USB Cables.....	22
Front Panel USB LED	22
First-time Device Installation in Windows®	23
Running the Framework	23
Framework Device Status Bar	23
Gamry Instrument Manager.....	24
Firmware Update	25
Auto Update All	26
Select And Update	26
Pairing your IMX8 Multiplexer	26
Test the Communications and Run Your Experiment.....	29



Table of Contents

Appendix A: IMX8 Multiplexer Specifications	33
Channel Characteristics	33
Channel Isolation	33
Local potentiostat.....	33
Power Input.....	34
Environmental.....	34
Appendix B: I/O Connections for the IMX8	35
Cell Cable Connector	35
Normal Cell Cable Connections	36
Potentiostat Connector.....	37
Connecting the IMX8 to Third-party Potentiostats	38
Appendix C: Certifications	39
Declaration of Conformity: No. DOC-2022-CE-IMX8	39
Certificate of Conformance	40
Declaration of Conformity: No. DOC-2022-UKCA-IMX8.....	41
Appendix D: Comprehensive Index	43

Chapter 1: Safety Considerations

Your IMX8 Multiplexer is supplied in a safe condition. This chapter of the IMX8 Operator’s Manual contains some information and warnings that you must follow to insure continued safe operation of the IMX8.

**Table 1-1
Safety Symbol Definitions**

Symbol	Description
	General Warning sign; Read throughout manual for all instances
	Warning symbol; Risk of electric shock
	Warning symbol; Observe humidity and water ingress requirements

Inspection

When you receive your IMX8 Multiplexer, inspect it for evidence of shipping damage. If you note any damage, please notify Gamry Instruments Inc. and the shipping carrier immediately. Save the shipping container for possible inspection by the carrier.



Warning: An IMX8 Multiplexer damaged in shipment can be a safety hazard. Do not operate damaged apparatus until a qualified service technician has verified its safety. Tag a damaged IMX8 Multiplexer to indicate that it could be a safety hazard.

Product Safety

The IMX8 Multiplexer has been designed, tested, and certified to meet the requirements of EN 61010, Safety requirements for electrical equipment for measurement, control, and laboratory use. The IMX8 Multiplexer circuitry is at voltages low enough to be considered safe.

The IMX8 Multiplexer’s circuitry does not contain voltages higher than 48 V DC. As a generalization, input and output voltages in the IMX8 Multiplexer are limited to 24 V. This voltage level is considered safe.

The “AC Adapter” supplied with the IMX8 Multiplexer is certified under EN 60950. The AC Adapter converts the AC mains voltage to 48 V DC, which is used to power the IMX8 Multiplexer.

Always use the AC adapter (power brick) supplied with your IMX8 Multiplexer to power the IMX8. One exception to this rule; power supplied by a Gamry IPH Interface Power Hub is also allowed.



Warning: Use only Gamry-approved DC power sources with your IMX8 Multiplexer. Other power sources may alter the performance and/or safety characteristics of the IMX8 Multiplexer.

AC Mains Connection to the Power Brick

The IMX8 Multiplexer does not connect directly to an AC Mains supply. Instead, the mains are connected to desktop AC adapter (power brick), which outputs 48 V DC, which in turn powers the IMX8 Multiplexer.



The IMX8 Multiplexer's AC Adapter is rated for operation from 100 to 240 V AC, 47 to 63 Hz. It should therefore be useful throughout the world.

The IMX8 Multiplexer is normally provided with an AC line cord suitable for your location. This AC line cord connects the AC mains to the AC power adapter. If your IMX8 Multiplexer has been provided without an AC line cord, or a cord that is not compatible with your local AC mains socket, obtain a line cord certified for use in your country. Contact your local Gamry Representative or e-mail to techsupport@gamry.com if you are uncertain what AC line cord to use.

Grounding in the IMX8 Multiplexer

Most of the IMX8 Multiplexer's circuitry and its metal case are connected to earth ground via the AC adapter. The cell connections to the Active cell can be isolated from earth ground if the System Potentiostat is isolated from earth. Inactive cells that are Open (not in the Shorted or Local Potentiostat modes) will also be isolated from earth ground.

Most electrochemical cells are isolated from earth ground, so isolation of the IMX8 Multiplexer and System Potentiostat from earth is not required. In these cases, connection of the System Potentiostat chassis to an earth ground may lower the noise seen in an electrochemical test. A Chassis Ground banana jack on the rear panel of the System Potentiostat easily implements this connection. Simply run a wire from this binding post to a suitable source of earth ground. The black 1.2-meter wire usually provided with Gamry Potentiostats facilitates this connection.



Sources of earth ground include:

- Most metal water pipes,
- the chassis of **most** electronic apparatus (which are generally earth-grounded), and
- the earth ground terminal of an AC mains power plug.

We recommend that you discuss grounding with an electrical or electronics professional prior to making this earth-ground connection.

This connection of the System potentiostat to an earth ground is not a "Protective Earth Ground" as defined in EN 61010. The IMX8 Multiplexer is safe in the absence of this connection.

Safety Considerations

This binding post is not intended for any use other than connecting the System Potentiostat to a functional earth ground to improve shielding against noise. Connecting this binding post to a hazardous voltage can create a significant safety hazard.



Warning: Do not earth ground the System Potentiostat if your electrochemical cell has earth ground. This is especially dangerous if the cell can source significant power (e.g., a battery, fuel cell, or capacitor). The cell can discharge through the IMX8 and/or System Potentiostat, possibly causing severe damage to the IMX8 or System Potentiostat.

Functional Grounding and Product Safety

As defined in IEC Publication 348, Safety Requirements for Electronic Measuring Apparatus, the IMX8 is a Class I grounded device.

When you use the IMX8 with an approved line cord, the connection to the functional earth ground is automatically made prior to making any power connections. The USB connection can also sometimes connect the IMX8 to functional ground if the computer is earth grounded.



Warning: Do not negate the protection of the IMX8's earth ground by any means. Do not use the IMX8 with a two-wire extension cord, with an adapter that does not provide for earth grounding, or with an electrical outlet that is not properly wired with an earth ground. If the earth ground is not properly connected, it creates a safety hazard, which could result in personal injury or death.

The IMX8 is supplied with a line cord suitable for use in the United States. In other countries, you may have to replace the line cord with one suitable for your type of electrical outlet. You must always use a line cord with a CEE 22 Standard V female connector on the instrument end of the cable. This is the same connector used on the US standard line cord supplied with your IMX8.



Warning: If you replace the line cord, you must use a line cord with the same polarity as that supplied with the IMX8. An improper line cord can create a safety hazard, which could result in personal injury or death.

The wiring polarity of a properly wired connector is shown in Table 1-2 for both US line cords and European line cords that follow the "harmonized" wiring convention.

**Table 1-2
Line Cord Polarities and Colors**

Area	Line	Neutral	Earth Ground
USA	Black	White	Green
Europe	Brown	Light Blue	Green/Yellow

If you have any doubts about the line cord for use with your IMX8, please contact a qualified electrician or instrument service technician for assistance. He or she can perform a simple continuity check that can verify the connection of the IMX8 chassis to earth and thereby check the safety of your IMX8 installation.

Temperature and Ventilation

Your IMX8 Multiplexer was designed to operate at ambient temperatures between 0°C and 40°C.



Caution: Be careful when operating the IMX8 in an enclosed space. The temperature within the enclosure must not exceed 40°C. You may need to provide ventilation holes or even forced air cooling for the enclosure if the temperature rises excessively.

Defects and Abnormal Stresses

Treat your IMX8 Multiplexer as potentially hazardous if any of the following is true of the unit:

- It shows visible damage,
- It does not operate properly,
- It has been stored for a long period of time under unfavorable conditions,
- It has been dropped or subjected to severe transport stress,
- It has been subjected to environmental stress (corrosive atmosphere, fire, etc.).

Do not use your IMX8 Multiplexer or any other apparatus if you think it could be hazardous. Have it checked by qualified service personnel.

Environmental Limits

There are environmental-limit conditions on the storage, shipping, and operation of this equipment. The IMX8 Multiplexer is **not** designed for outdoor use.

Storage	Ambient Temperature	–20°C to 60°C
	Relative Humidity	Maximum 90% non-condensing
Shipping	Same as storage plus	
	Acceleration	Maximum 30 G
Operation	Ambient Temperature	0°C to 40°C
	Relative Humidity	Maximum 90% non-condensing



Warning: The IMX8 Multiplexer is not designed for operation in conditions where liquid water may enter the chassis, or water vapor may condense within the chassis. Operation of a IMX8 Multiplexer that has water within the chassis can create a safety hazard, which could result in personal injury or death.

Cleaning

Disconnect the IMX8 Multiplexer from all power sources prior to cleaning.

Use a cloth *lightly* dampened with either clean water or water containing a mild detergent to clean the outside of the IMX8 Multiplexer enclosure. Alternatively, you can use isopropyl alcohol. Do not use a wet rag or allow fluid to enter the IMX8 Multiplexer enclosure. Do not immerse the IMX8 Multiplexer in any type of cleaning fluid (including water). Do not use any abrasive cleaners.

Service

Your IMX8 Multiplexer has no user-serviceable parts inside. Refer all service to a qualified service technician.



Warning: Never operate the IMX8 Multiplexer with any cover or panel on the chassis open. Dangerous voltages may be present at several points within the IMX8 Multiplexer chassis, including PC board traces. Always remove the power connection before opening the IMX8 Multiplexer case.

RF Warning

Your IMX8 Multiplexer generates, uses, and can radiate radio-frequency energy. The radiated levels are low enough that the IMX8 Multiplexer should not create an interference problem in most industrial laboratory environments. The IMX8 is likely to cause radio-frequency interference if operated in a residential environment.

Electrical Transient Sensitivity

Your IMX8 Multiplexer was designed to offer reasonable immunity from electrical transients. However, in severe cases, the IMX8 could malfunction or even suffer damage from electrical transients. If you are having problems in this regard, the following steps may help:

If the problem is static electricity (sparks are apparent when you touch the IMX8):

- Placing your IMX8 on a static-control work surface may help. Static-control work surfaces are now generally available from computer-supply houses and electronics-tool suppliers. An antistatic floor mat may also help, particularly if a carpet is involved in generating the static electricity.
- Air ionizers or even simple air humidifiers can reduce the voltage available in static discharges.

If the problem is AC power-line transients (often from large electrical motors near the IMX8):

- Try plugging your IMX8 into a different AC-power branch circuit.
- Plug your IMX8 into a power-line surge suppressor. Inexpensive surge suppressors are now generally available because of their use with computer equipment.

Safety Considerations

Contact Gamry Instruments, Inc. if these measures do not solve the problem.

CE Compliance

The European Community has instituted standards limiting radio-frequency interference from electronic devices and mandating several safety requirements. Gamry Instruments, Inc. has modified its instruments, including the IMX8, to comply with these standards.

The relevant CE regulations include EN 61010.

RoHS Compliance

The IMX8 Multiplexer has been built using lead-free components and lead-free solder. It is in compliance with the European RoHS initiative.

Chapter 2: Introduction

About this Manual

This manual covers the installation, safety, and use of the Gamry Instruments IMX8 Multiplexer.

This manual describes use of an IMX8 Multiplexer with Revision 7.9 (and later revisions) of the Gamry Framework software. It is equally useful when setting up a newly purchased instrument or modifying the setup of an older instrument for use with new software.

You will find dry technical material such as specifications and connector pin-out diagrams in the Appendices.

This manual does not discuss software installation or software operation in any detail. Software support for the IMX8 Multiplexer is described in the Gamry Framework's Help system.

All the Gamry Instruments' applications running under the Gamry Framework control the IMX8 Multiplexer via an IMX object. See the Framework's Help system for information concerning IMX objects and their functions.

About the IMX8 Multiplexer

The IMX8 Multiplexer was developed to increase the throughput of your electrochemical testing program. It allows one potentiostat/galvanostat/ZRA to drive up to eight electrochemical cells. Under the control of an external computer, the IMX8 connects one cell at a time to the potentiostat, which makes an electrochemical measurement on that cell.

The IMX8 was specially designed for the needs of electrochemists. Extra features such as sense line and shield-switching, and control of inactive cells separate the IMX8 – designed specifically for electrochemists – from other general-purpose switching devices.

The IMX8 has been integrated into Gamry Instruments' electrochemical applications relevant to the IMX8 that run under the Gamry Framework. It allows many of the DC Corrosion measurement applications to increase their throughput by testing multiple cells in a single test run. In this system a sophisticated Microsoft Windows®-program is used to control both the IMX8 and a Gamry Instruments potentiostat.

However, the IMX8 is not restricted to use in corrosion testing or use with Gamry Instruments hardware or software. It was designed to work with other potentiostats, including those sourcing as much as 1.5 amperes of current. Refer to Gamry Instruments' Echem Toolkit™ for use with 3rd part potentiostats.

This chapter of the IMX8 Operator's Manual provides an overview of the operation of the IMX8. It discusses the following topics:

- Operation overview
- Switching and inactive cell control

The material in this chapter is only an overview. If you are using your IMX8 Multiplexer with Gamry Instruments software, this overview should give you sufficient understanding to make intelligent use of your IMX8.

Operation Overview

Figure 2-1 shows a "typical" electrochemical test system built around an IMX8 Multiplexer. Up to eight cells can be connected simultaneously to an IMX8. The label on the block marked as a potentiostat is slightly misleading. Most potentiostats can also be used as a galvanostat or as a ZRA (zero-resistance ammeter) in an IMX8 system.

In the description of this figure, keywords are in bold type and are defined in the next section.

Figure 2-1
Typical Electrochemical Test System Using an IMX8 Multiplexer

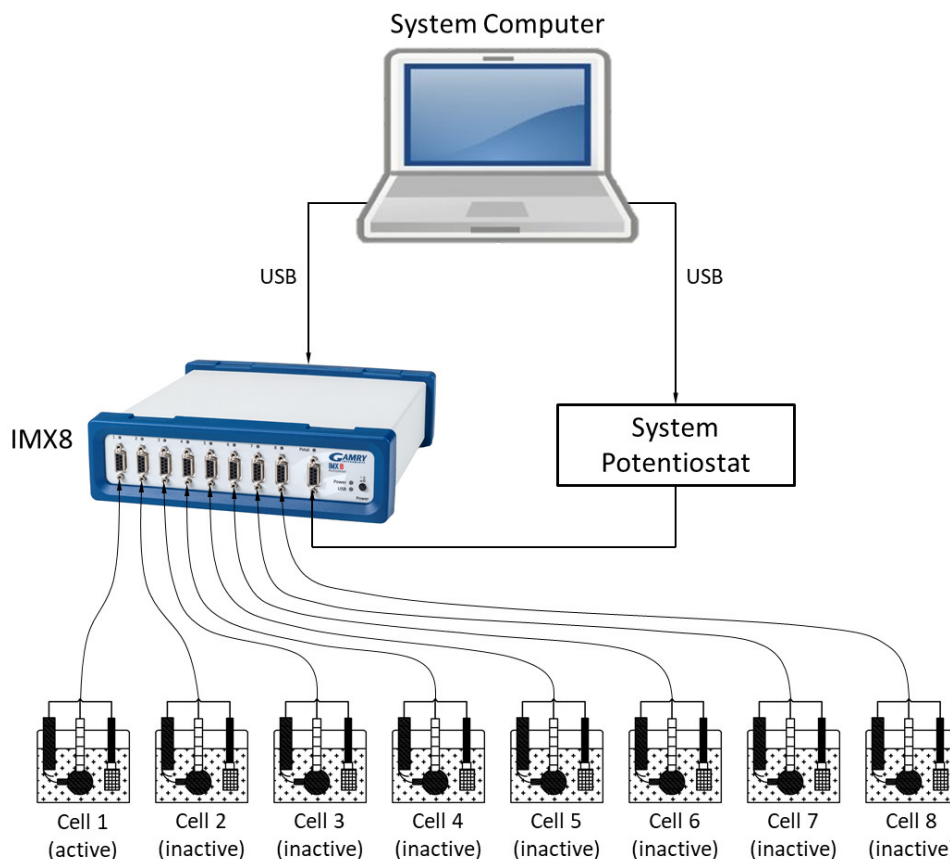

The **system computer** is a critical component of the system. It controls the IMX8 by sending it simple commands through a USB connection.

The most important function of these commands is to select which cell is **active** (connected to the **system potentiostat**). You can think of an IMX8 as a complex switch. One of the eight **cell cables** on the IMX8 is switched so that it connects to the potentiostat's cell cable. All of the wires (including sense leads and shields) in the cell cable are switched. Other commands select the IMX8's control mode for the cells that are **inactive** (not presently connected to the potentiostat).

The **system computer** also controls the **system potentiostat**. Most modern potentiostats generate digital signals. Primarily, a standard USB connection is used to digitally control these potentiostats. In the case of analog potentiostats, analog signals from a D/A and A/D computer interface can be sent. When a cell is connected to the system potentiostat cell leads, the computer causes a test to be run on that cell. The test can be as simple as a single current or potential measurement or as complex as a cyclic scan or acquisition of an EIS spectrum. The computer software and **system potentiostat** are responsible for taking the measurement and storing it.

The **system potentiostat** in Figure 2-1 is shown as a "black box". The IMX8 is designed to work with virtually any potentiostat. The relays in the IMX8 can carry currents up to 1.5 A, allowing use of the IMX8 with most high-performance potentiostats.

In a typical IMX8 experiment, the **system computer** cycles through the cells. Each cell is connected in turn to the **system potentiostat** and used to collect a measurement. Usually, the computer delays at the end of each cycle through the cells so that the measurements on each cell are separated by a fixed time period.

Keyword Definitions

The following key terms are used throughout this manual.

- **Active Cell**

The active cell is the cell (if any) currently connected to the system potentiostat. Any electrochemical measurements are made on the active cell.
- **Cell**

The term cell is used to describe either an electrochemical cell or the switches needed to connect an electrochemical cell to the system potentiostat.
- **Channel**

An IMX8 contains eight channels. A channel includes cell-switching, a local potentiostat and a D/A converter. The term cell is used when only the cell-switching portion of a channel is being discussed.
- **Inactive Cell**

The term inactive cell is any cell not currently connected to the system potentiostat. Inactive is a slightly misleading term since an inactive cell can actually be potentiostated by the IMX8's local potentiostat on that channel. An inactive cell can be also shorted to mimic an active cell in ZRA mode.
- **Inactive Mode**

Inactive cells can be open, connected to a local potentiostat, or shorted. The term inactive mode describes this choice of control mode for inactive cells.
- **Local Potentiostat**

A simple low-current potentiostat that maintains potential control on inactive cells. Unlike the system potentiostat, the local potentiostat is incapable of making electrochemical measurements.
- **System Computer**

The computer responsible for coordinating operation of an IMX8-based electrochemical test system, not to be confused with the simple micro-controller buried within the IMX8.
- **System Potentiostat**

This is the potentiostat responsible for making electrochemical measurements on the cells used in the experiment. The system potentiostat is typically a full-featured, computer-controlled instrument.

Switching and Inactive Cell Control

In the Operation Overview, we said you can think of the IMX8 as a complex switch. This section of the manual describes the IMX8-switching in some detail. In addition, control modes for inactive cells are discussed.

Each of the eight IMX8 channels is made up of an independent set of switches and control circuits. Figure 2-2 is a simplified schematic diagram for one channel of the IMX8. Switches connected with dotted lines are always switched together and are therefore treated as one multi-pole switch. All the switches are under control of the system computer. Shield relays are not shown.

Figure 2-2
Simplified Schematic of a Single IMX8 Channel

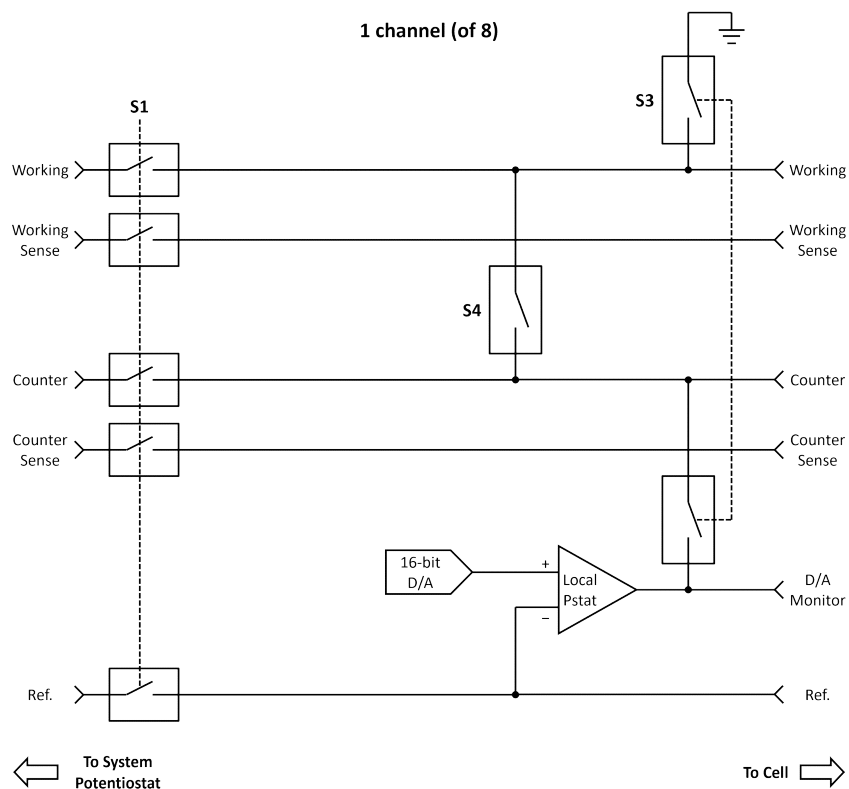

The cell cable from the system potentiostat is connected at the left side of the schematic. The system-potentiostat cell cable can be connected to any of the IMX8 channels. The system computer must ensure that only one cell at a time is connected to the system potentiostat.

Switch S1 controls which cell is active. **S3** and **S4** control the inactive mode of the cell on this channel.

Looking at the schematic, you can see that switch **S1** connects this channel's cell to the system potentiostat. An active channel always has **S3** and **S4** open. The relays in **S1** are rated to carry 1.5 A and switch 500 mA. You can normally use the IMX8 with potentiostats rated at up to 100 V of output compliance and 1.5 A of output current.

To avoid transients, Gamry's software always turns off the cell at the system potentiostat prior to switching **S1**. The IMX8 switches all its relays nearly simultaneously (even those in different channels), but there is still about 1 millisecond in which the relay pattern in the IMX8 is in neither the initial or final configuration. Switching transients as the IMX8 switches channels with a "live" potentiostat can be particularly severe because the system potentiostat's feedback goes through one of the **S1** relays. To avoid the problem, turn off the cell at the system potentiostat before switching channels.

You have a choice of three different control schemes for inactive cells. These are tabulated in Table 2-1 along with the active mode.

Table 2-1
IMX8 Control Modes

Mode	Switch S1	Switch S3	Switch S4
Active	Closed	Open	Open
Open	Open	Open	Open
Local Potentiostat	Open	Closed	Open
Shorted	Open	Open	Closed

The inactive control mode labeled “open” is the simplest. In this mode the cell is disconnected and isolated from both the system potentiostat and the IMX8. No cell current can flow between any electrodes. This is the most common inactive mode in corrosion studies, where the cell behavior at open circuit is of interest.

The inactive control mode labeled “local potentiostat” is used to maintain potential control between readings made with the system potentiostat. If you know something about operational amplifiers and potentiostats, you may recognize that the operational amplifier in Figure 2-2 is wired as a simple potentiostat. With **S3** closed, the working electrode is connected to the ground on the IMX8 circuit board and the counter electrode is connected to the output of an operational amplifier. The feedback for this amplifier is taken from the cell’s reference electrode. This mode can be used whenever it is important to maintain potential control between readings. One experimental example is tests on amperometric chemical sensors.

Unlike a typical system potentiostat, the local potentiostat is very limited in capability. The amplifier in this local potentiostat is not a large power amplifier. Its output is typically capable of generating ± 30 mA at up to ± 10 V. The local potentiostat has no cell switch other than **S3**, and it cannot measure current.



Caution: You can damage the local potentiostat’s amplifier if the reference electrode potential exceeds ± 24 V versus the IMX8 chassis.

The cell can be potentiostated at a voltage that is set via the D/A converter seen in Figure 2-2. This is a 16-bit converter operating at a resolution of $152.59 \mu\text{V}$ per bit. The maximum voltage available is ± 4.9 V.

The final inactive mode is label “shorted” in Table 2-1. In this mode a relay shorts the working and counter electrodes. This mode was added so that the IMX8 could be used in galvanic corrosion studies. In a galvanic corrosion experiment, the current flow between two electrically connected metals is measured. The device that makes this measurement is called a zero-resistance ammeter (ZRA) .

In the shorted inactive mode the two metals are connected, even when the system ZRA is measuring other channels.

Both the local potentiostat and shorted mode have voltage inaccuracies caused by the cell current. The working electrode is nominally at zero volts versus earth ground. When cell current is present, resistance in relays, wires, and connectors causes the voltage to differ from zero. In the shorted mode the counter lead also has resistance that contributes voltage error. With a 1.5 m Gamry Instruments cell cable, the resistance in each cell lead should be less than 0.2Ω . At 30 mA of current, the voltage error in the local potentiostat mode can be as large as 6 mV. In the shorted mode and at the same current, the total voltage error can be 12 mV.

Notational Conventions

In order to make this manual more readable we have adopted some notational conventions. These are used throughout this manual and all other Gamry Instruments manuals:

Introduction

- Numbered lists. A numbered list is reserved for step-by-step procedures, with the steps always performed sequentially.
- Bulleted list. The items in a bulleted list, such as this one, are grouped together because they represent similar items. The order of items in the list is not critical.
- File names and folders. Inside paragraphs, references to computer files and Windows® folders are capitalized and placed within quotes, for example: "C:\MYGAMRYDATA\CV.DTA" and "GAMRY.INI".

Chapter 3: Installation

This chapter of the IMX8 Multiplexer Operator's Manual covers normal installation of the IMX8. Both installation as part of a Gamry Framework-based electrochemical-measurement system and installation as a component in a user-configured system are discussed.

These instructions assume use with Gamry's Framework Software Revision 7.9 or higher.

Figure 3-1
Front View of an IMX8 Multiplexer



Initial Visual Inspection

After you remove your IMX8 Multiplexer from its shipping carton, check it for any signs of shipping damage. If you find any damage, please notify Gamry Instruments, Inc., and the shipping carrier immediately. Save the shipping container for possible inspection by the carrier.



Caution: An IMX8 damaged in shipment can be a safety hazard. Do not operate a damaged apparatus until a qualified service technician has verified its safety. Tag a damaged IMX8 to indicate that it could be a safety hazard.

Physical Location

Place your IMX8 Multiplexer on a flat workbench surface. You need access to the rear of the instrument because some cable connections are made from the rear. The IMX8 is not restricted to operation in a horizontal position. You can operate it on its side, or even upside-down.



Caution: The IMX8 has an internal fan which distributes the heat generated by the IMX8 circuitry to the metal chassis. Blocking heat transfer from the chassis to the environment could cause IMX8 overheating.

If you place your IMX8 Multiplexer within an enclosed space, make sure that the temperature within that space does not exceed the 40°C ambient temperature limit of the IMX8. Be particularly careful if a computer or other heat-dissipating equipment is mounted in the same enclosure as the IMX8.

The IMX8 Multiplexer has not been designed for outdoor use.

Quick-start Guide for System Installation

Your shipment includes a short document entitled Quick-start Installation Guide–USB Potentiostat. It contains the latest instructions for installing Gamry hardware and software onto a computer system. If this document is missing, the following information should be sufficient for you to install the Gamry Framework Software and Gamry potentiostat onto your computer.

Connection to Gamry Instruments Reference 600+ or 620 and Interface 1000 or 1010 potentiostats

Connection of your IMX8 to a Gamry Instruments Reference 600+ or 620 and Interface 1000 or 1010 potentiostat respectively is quite simple. Gamry Instruments supplies a standard cable (part number 985-00080) that properly connects the cell wires. This 1.5 m cable is equipped with a male 9-pin D-connector on the IMX8 end and a male 25-pin D-connector on the Reference 600+ or 620 and Interface 1000 or 1010 end.



Caution: Never substitute a generic 25-to-9-pin cable designed for computer interconnection for this cable. Gamry Instruments' cable includes individual shielding for several signals in this cable. Use of a generic cable is likely to create excessive noise and system oscillation.

The Reference 600+ or 620 and Interface 1000 or 1010 can identify the cable plugged into its cell connector. It detects the presence of an IMX8 Multiplexer in your system. The Reference 600+ or 620 and Interface 1000 or 1010 cannot identify the cables used to connect the eight individual cells to the IMX8.

EIS performance with an IMX8 and a Reference 600+ or 620 and Interface 1000 or 1010 is optimal when all the cell cables are 1.5 m cables. All other cables may create errors in phase and magnitude.

Connection to a Third-party Potentiostat/Galvanostat

Connecting the IMX8 to a third-party potentiostat/galvanostat is more of a problem: You have to build a custom cable. See Appendix C of this manual for the pin-layout of the IMX8 **Potentiostat connector** and for hints on cable construction. We strongly recommend that you contact us prior to constructing the cable.

Cell Cable Installation

Each cell to be tested in an experimental run requires a cell cable.

When you are using the IMX8 with a Gamry Instruments potentiostat, Cell Cable connections to the cell are made in the manner described in the potentiostat's Operator's Manual. Cell connections when the IMX8 is used with a third-party potentiostat may not follow the normal Gamry conventions, so you should contact Gamry Instruments to obtain special instructions if this is your situation.

Your IMX8 Multiplexer comes with eight 1.5 m long cell cables with a male 9-pin D-connector on the IMX8 end. The other end of the cable has banana-plug/alligator-clip termination to connect to a cell. Longer cables as well as specialized cables are also available, including cables designed for connection to standard three-terminal corrosion-monitoring probes. Contact support for more information.

If you need to design a cell cable for your specific needs, refer to the pin-layout of the IMX8 cell cable in Appendix B of this manual.

Computer Requirements

Before you connect an IMX8 Multiplexer to a host computer, you must ensure that your computer meets these simple requirements:

- A computer based on one of the x86 family of Intel™ microprocessors or a 100%-compatible processor from another vendor.
- Microsoft Windows® 10 or newer is required with Gamry Framework™ software version 7.9 and above. Both 32-bit and 64-bit versions of these operating systems are supported.
- A USB port that supports Full Speed (12 Mbits/second) or High Speed (480 Mbits/second) USB transfers. It must be compatible with Revision 1.1 or Revision 2.0 of the USB specification.

Gamry's Windows®-based application software packages may impose additional, more stringent requirements. See the software documentation or contact a Gamry representative for details.

Software Installation

The IMX8 Multiplexer is compatible with the Windows® Plug & Play configuration system. Like most Plug & Play hardware, it is best if you install the software for the IMX8 Multiplexer *before* you install the instrument hardware.

Gamry's software can be installed from a physical medium such as a DVD or a pre-programmed software flash drive, or it can be installed via an Internet download. The most up-to-date download can be found on www.gamry.com.

If you have inserted the Gamry DVD or flash drive into your computer and the Gamry Setup program does not start automatically:

- 1) Navigate to the root folder of the device containing the Gamry Software (DVD or flash drive) or to a Windows® folder containing the Gamry Software.
- 2) Run the program called "AUTORUN.EXE" found in this folder.

If you do not know how to navigate to the Gamry Installation device, consult your local computer expert or network administrator or email techsupport@gamry.com.

"AUTORUN.EXE" runs a set-up program. In most cases, you can choose the default choices or the most obvious choices on all screens shown during the set-up process. The installation process installs Gamry's Framework application packages and installs any multiplexed scripts that are available for those applications.

Reboot your Computer after Software Installation

Reboot your computer after the Gamry Setup program is done. The Setup program normally offers you the opportunity to do so. USB device drivers are usually loaded when Windows boots up. Following Setup, you may not be able to use your IMX8 Multiplexer until the drivers are loaded.



Device-driver installation may not occur until a while after the Windows® Desktop appears. On a slow computer, or a busy computer with lots of active applications, the delay before driver installation can be a minute or more.

USB Cables

The IMX8 Multiplexer connects to the computer using a standard High Speed USB A/B cable. A suitable cable was shipped with your IMX8 Multiplexer. If this cable is lost, you can get a replacement at almost any computer retailer. The replacement cable should be rated for USB 2.0 High Speed USB operation.

An A/B USB cable has different connectors on each end. The end with a wider, rectangular connector plugs into a USB port on your computer (or a similar port on a USB hub). The end with a nearly-square connector plugs into the USB port on the rear panel of the IMX8 Multiplexer (see Figure 3-2).

The USB connection can be “hot-plugged”. This means that both the computer and the IMX8 Multiplexer can be powered up before the USB cable is plugged in. Unlike many other instrument system connections, you need not power down the system before plugging in the USB.

You may also safely remove the USB cable without powering down the IMX8 Multiplexer and your computer. Be aware however, that this may have undesirable consequences if the system is currently taking data or performing an electrochemical experiment.

Figure 3-2
Rear Panel of the IMX8 Multiplexer



Front Panel USB LED

The front panel **USB** LED provides a simple test of two aspects of normal IMX8 Multiplexer USB operation. It has three *normal* states:

Unlit	The USB cable is disconnected, or the USB connection is disabled by the host computer.
Continuous green	A valid cable connection has been made and the IMX8 USB processor is receiving power from the USB cable.
Flashing yellow	Valid USB messages are being transferred between the computer and the IMX8 Multiplexer.
Continuous red	A software download is in progress, or a USB communications error. Do not turn off the IMX8 Multiplexer.

The flashing state only occurs when Gamry Instruments application software is running.

The firmware update process is described later in this chapter.

First-time Device Installation in Windows®



These instructions presume you have already installed Gamry software Revision 7.9 or higher.

Running the Framework

Regardless of your electrochemical application, Gamry recommends running the Gamry Framework after you install new Framework software or add an instrument to your system. The Framework Instrument Manager allows you to:

- Rename instruments,
- Calibrate instruments,
- Manage instrument firmware,
- Authorize specific applications for use with specific instruments

Run the Gamry Framework by clicking on the icon it installed on the Windows® desktop. You can connect and power any Gamry instrument either before or after you start the Framework.

Framework Device Status Bar

By default, the Gamry Framework shows a Device Status Bar under its main menu (see Figure 3-3). If you don't see the Device Status Bar when you run the Gamry Framework, it has been disabled in the Framework **Options** menu.

Potentiostat Devices (instruments) that are connected to the computer appear on this bar. The round indicator associated with each device shows its status:

Green	The device is available to run experiments.
Orange	The device is currently running an experiment.
White	The device is connected to the system but is not usable. This is generally the result of a mismatch between the Framework software and the device's firmware. You can use the Gamry Instrument Manager to fix the mismatch.

The screen capture below shows a Framework screen with three USB instruments connected.

Figure 3-3
Framework with Three Potentiostats and One Running Test

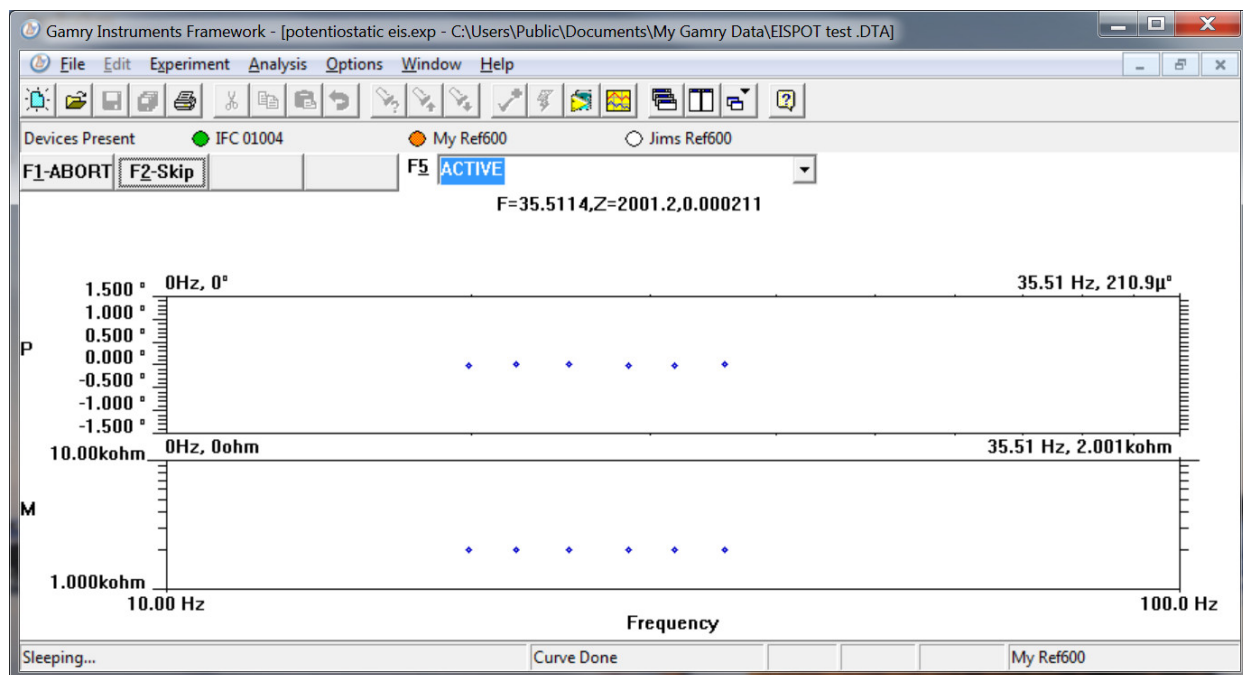

The Interface 1000 (**IFC 01004**) in this system is shown with a green indicator because it is installed and ready to run. The Reference 600 labeled **My Ref600** has a yellow indicator because it is recording the EIS spectrum shown on the screen. The Reference 600 labeled **Jims Ref600** has a white indicator, showing it is plugged in but cannot be used. This is an indication of obsolete firmware.

Though no IMX8 Multiplexer was used in this example, its status indicator behaves in the same manner described above.

Gamry Instrument Manager

Use Gamry's Instrument Manager (GIM) application make changes to the configuration of your IMX8 Multiplexer system. Get access to this dialog box via the **Options** menu in the Gamry Framework.

Use the Instrument Manager to:

- Rename devices
- Delete devices that are not currently connected to the computer
- Select the order in which devices appear in menus
- Update firmware within devices
- Pair your Multiplexer with a potentiostat

Figure 3-4 shows an example of the Gamry Instrument Manager window with an IMX8 Multiplexer.

Figure 3-4
Instrument Manager Dialog Box

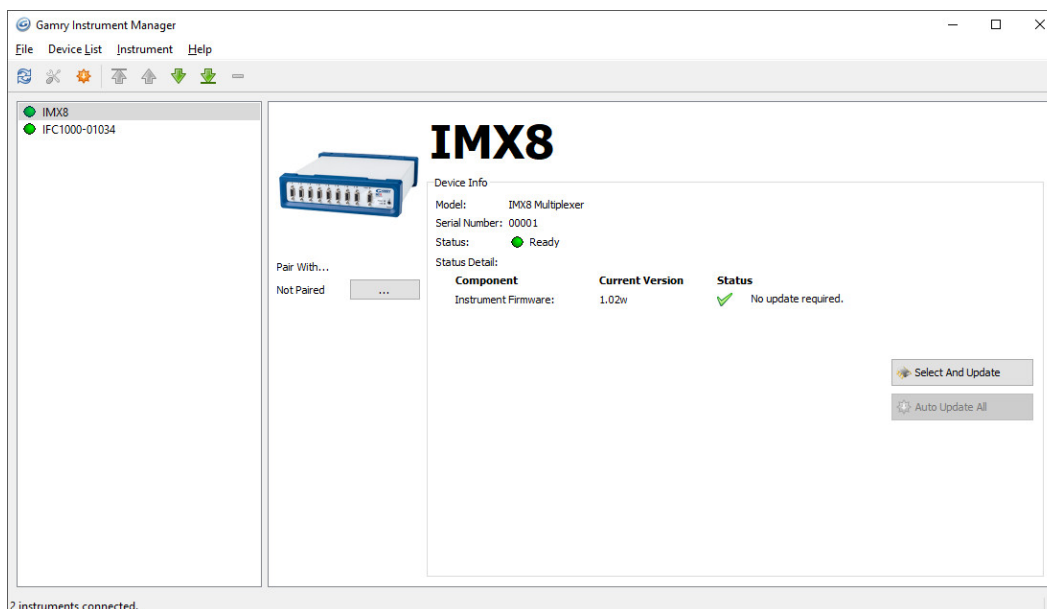

GIM appears automatically when a new instrument is connected to the computer. You can start GIM anytime by opening Framework and selecting **Options > Instrument Manager....**

GIM is always in its own window, separate from the Framework window.

Each Gamry device in the system appears in the list on the left. All Gamry Instruments devices that are known to the system are displayed in the **Instrument Manger**. Select an instrument by clicking on its name. Selecting an instrument that is connected and idle blinks its Power LED. After a moment, your potentiostat should appear next to **Devices Present** along with a green virtual LED. Repeat for additional devices.

Firmware Update

Your IMX8 Multiplexer was shipped with the latest version of all its firmware. From time to time, Gamry makes changes to the instrument's firmware code, and a firmware update is required to make use of the new or improved code.

There is only one firmware image that you can update on your IMX8 Multiplexer.





- Instrument Firmware Handles most of the functions of the IMX8 Multiplexer.

Appropriate update files (firmware images) can be obtained from the Gamry Instruments website at www.gamry.com. Download the file containing the new image and save it onto your computer's hard disk. Alternatively, every Gamry Software disk (or Gamry Software Flash Drive) contains a firmware folder that contains firmware files compatible with that DVD's Framework revision.



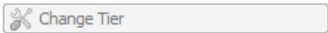



GIM automatically determines if the software and firmware are compatible. The status of compatibility is shown in the Device Info area.

If there is a conflict, this area shows the following (here using a Reference 3000 as an example):

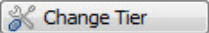
Installation

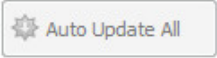
Device Info			
Model:	Reference 3000	Host Software Revision:	7.04.4758
Serial Number:	30121		
Tier:	REF3000E		
Firmware Revision:	4.00	 Warning! Version 4.15 or greater required	
PLD Revision:		Not supported	
Comm Revision:	2.24	 No update required.	
Status:		Update Required	

If the firmware is compatible with software version, the **Device Info** area appears as:

Device Info			
Model:	Reference 600 Plus	Host Software Revision:	7.06.5945
Serial Number:	30008		
Tier:	REF600PE		
Firmware Revision:	4.30	 No update required.	
PLD Revision:	Not updatable		
CTRL PLD Revision:	Not updatable		
Comm Revision:	2.24	 No update required.	
Status:		Ready	

Auto Update All

If no updates are required to use the instrument, this tool is grayed out. When your firmware revision is incompatible, the **Auto Update All** button is active. This tool automatically selects the compatible firmware and installs it. Gamry Instruments recommends that you use this button. To use this tool, take the following steps:



Caution: Do not power off or disconnect the instrument during this process. Doing so can cause irreversible damage to the instrument.

Click the **Auto Update All** button. A window appears giving information on what version of firmware is currently installed, and what version will be installed. The install process starts automatically. After the relevant firmware is updated, a window appears confirming the process is complete and successful. Click the **OK** button. The instrument is now ready to be used.

Select And Update

The **Select And Update** button is available at all times, even if an update is not required. Gamry recommends not altering the firmware if it is not necessary. This tool allows you to change individual firmware.



Please contact Gamry Tech Support if you are unsure if firmware modification is required.

Pairing your IMX8 Multiplexer

Pairing your Multiplexer with one of your potentiostats is simple. Two different methods within the Framework software can be used.

Installation

1. Be sure your host computer is on, the multiplexer is on, and your potentiostat is on.
2. Run the Gamry Framework software.
3. In the main menu bar, choose **Options > Instrument Manager...**

The Gamry Instrument Manager window opens.

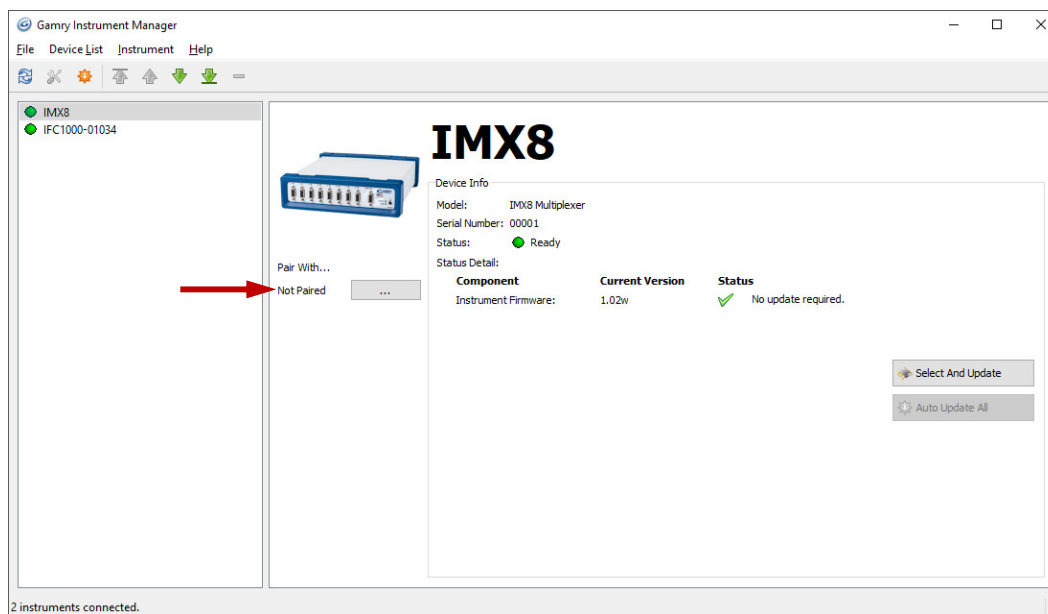

- a. Click the ... button under **Pair with...** to open the selection window.

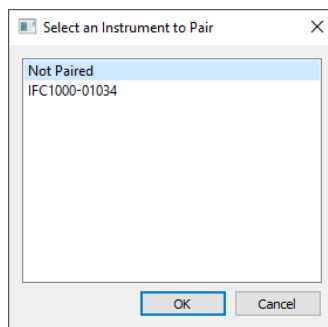

- b. Select the potentiostat you want to pair with your IMX8 Multiplexer and press **OK**
The Instrument Manager displays now the potentiostat paired with your IMX8 Multiplexer.

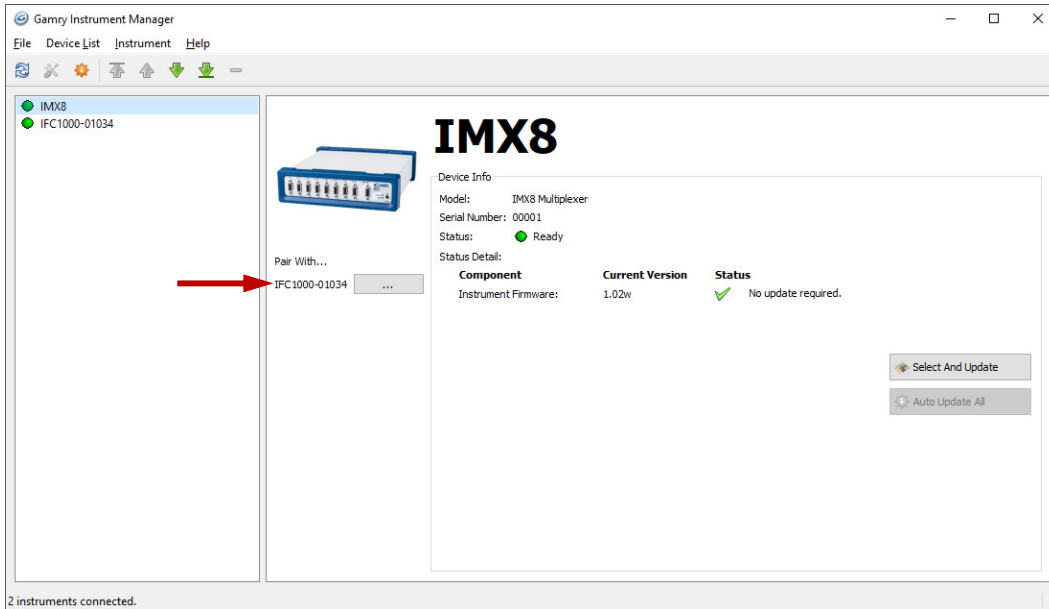

4. In the main menu bar, choose **Experiment > Utilities > Multiplexer Configure and Test**. The **Select Function** window appears.

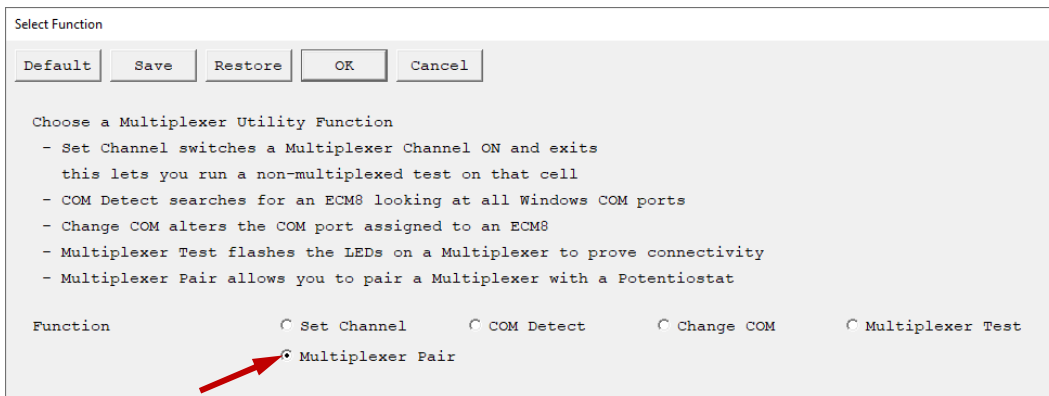

- a. Select **Multiplexer Pair**.
Click the **OK** button.
- b. The **Select Multiplexer to Pair** window opens.
Select a multiplexer.

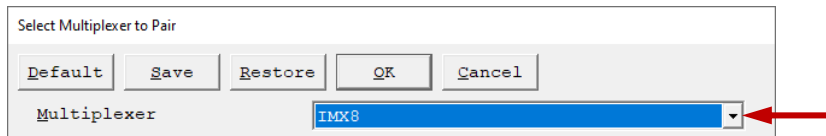

- Click the **OK** button.
- c. The **Select Potentiostat to Pair with IMX8** window opens.
Select a potentiostat.

Installation

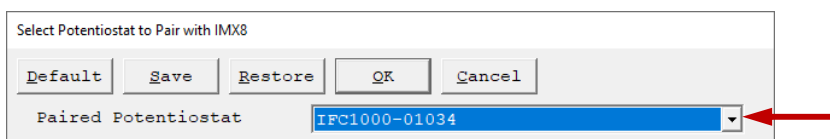

Click the **OK** button.

- d. A window confirms the successful pairing process.

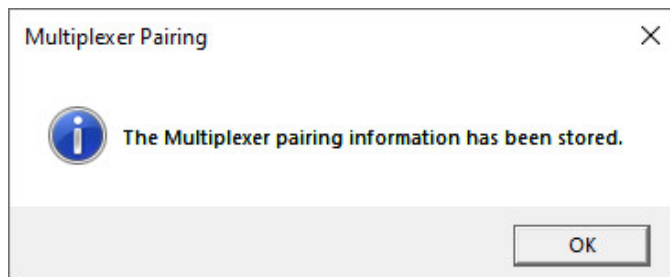

Click the **OK** button.

Test the Communications and Run Your Experiment

1. Be sure your host computer is on, the multiplexer is on, and your potentiostat is on.
2. Run the Gamry Framework software.
3. In the main menu bar, choose **Experiment > Utilities > Multiplexer Configure and Test**.

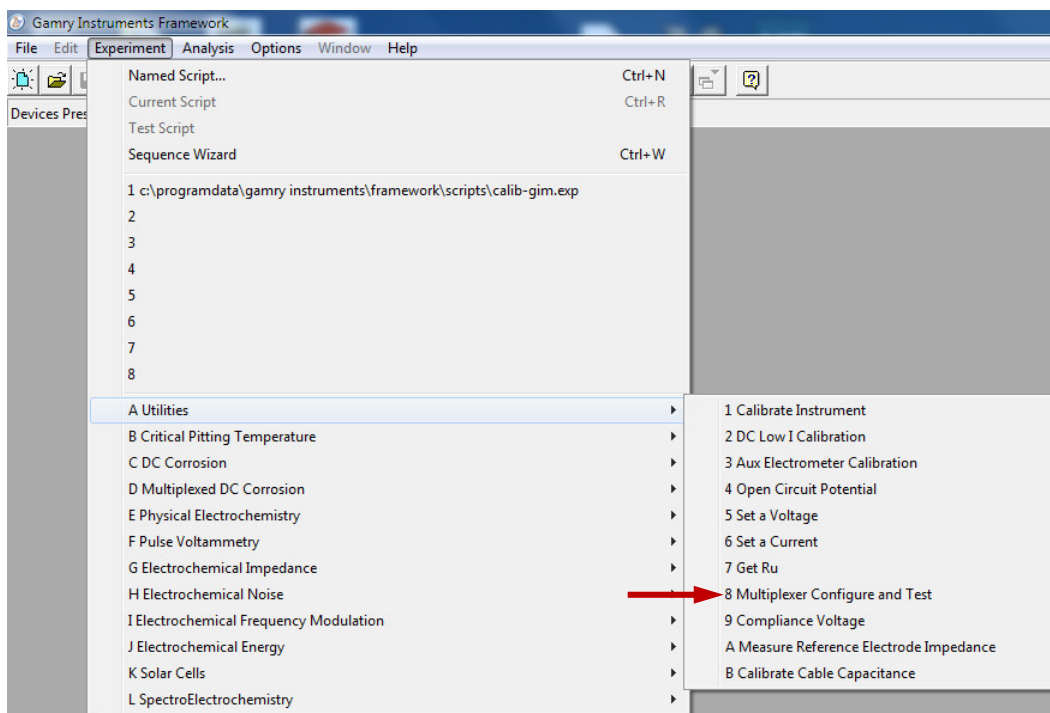

The **Select Function** window appears.

- a. Select **Multiplexer Test**.

Installation

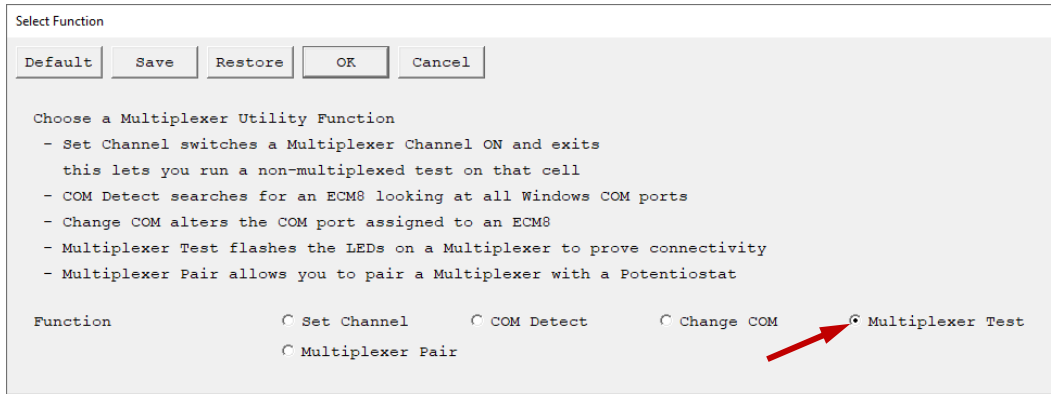

Click the **OK** button.

A window appears which prompts you to select a Multiplexer.

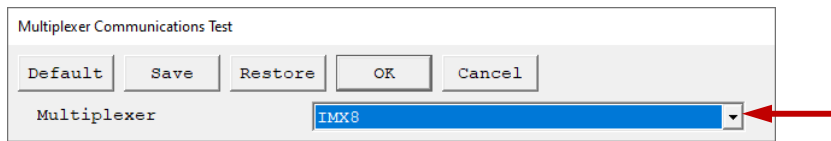

Click the **OK** button.

Watch the eight amber LEDs on the front of the multiplexer illuminate in sequence two times. Listen for the simultaneous clicks of the relays.

b. Select **Set Channel**.

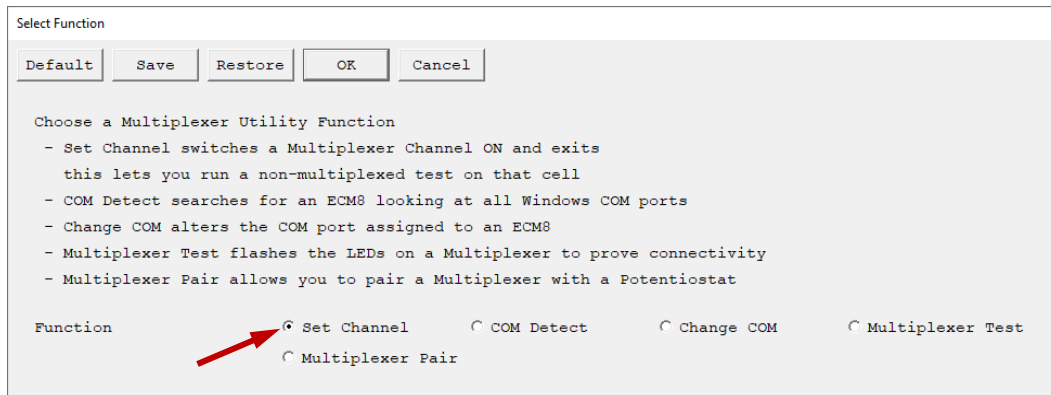

Click the **OK** button.

A window appears which prompts you to select a Multiplexer.

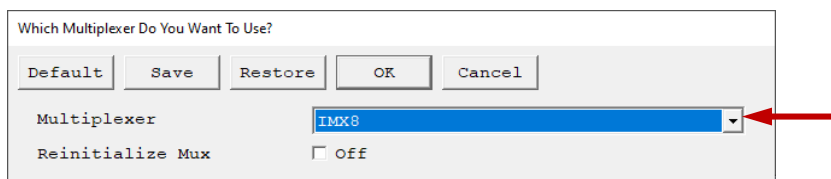

Click the **OK** button.

Activate the checkboxes corresponding to the active channels on the multiplexer.

Installation

Multiplexer 00001 Setup

Default Save Restore OK Cancel

Local Pstat 1 Off E (V) 0

Local Pstat 2 Off E (V) 0

Local Pstat 3 Off E (V) 0

Local Pstat 4 Off E (V) 0

Local Pstat 5 Off E (V) 0

Local Pstat 6 Off E (V) 0

Local Pstat 7 Off E (V) 0

Local Pstat 8 Off E (V) 0

Active Cell 1 2 3 4
 5 6 7 8
 None

Active Mode Normal ZRA

Reinitialize Mux Off

When a particular channel runs, the Channel LED for that channel illuminates.

Table 3-1
Channel LEDs

Status	LED color
Active channel	Green
Inactive channel	Off
Inactive mode of Local Potentiostat	Yellow

Appendix A: IMX8 Multiplexer Specifications

All specifications are at an ambient temperature of 25°C, with the IMX8 Multiplexer powered using the external power supply shipped with the unit (116 V AC). All specifications are after software calibration.

All specifications are subject to change without notice.

Channel Characteristics

Modes		Active Off Local Shorted	
Channel switching time	Max	10	ms
Cell current	Max	0.5	A
Input voltage (measured versus IMX8 chassis ground)	Typ	± 12 ± 24	V
operating no damage			
Counter Electrode voltage (measured versus IMX8 chassis ground)	Typ	± 30	V

Channel Isolation

Current leakage (to active channel pin from any source)	Max	2	nA
Impedance (equiv. impedance to IMX8 chassis ground)	Typ	>500 <20	M Ω pF

Local potentiostat

Compliance Current (500 Ω load)	Typ	± 20	mA
Compliance Voltage (1 k Ω load)	Typ	± 11	V
Applied E-range (Working versus Reference)	Typ	± 4.9	V
Resolution	Typ	152.59	$\mu\text{V/bit}$
Zero-offset error ¹ (0 V output into 10 k Ω load)	Typ Max	<0.2 10	mV
Gain error ¹ (10 k Ω load)	Typ	<0.2	%
Reference input current	Typ	<5	pA

¹ Applied voltage error is sum of zero-offset and gain error.

Power Input

Input voltage ranges (selectable)		100, 120, 220, 240	V rms
Allowed voltage variation (all ranges)	Typ	±10	%
Power (worst case)	Typ	<15	VA

Environmental

Operating Temperature Range		0 to 40	°C
Relative Humidity	Max	90 (non-condensing)	%
Storage and Shipping Temperature		-20 to 60	°C
Maximum Shipping Acceleration		30	G

Appendix B: I/O Connections for the IMX8

The IMX8 Multiplexer has various connectors on its front panel. This section discusses these connectors and their pin assignments in detail.

Figure B-1
Front Panel of the IMX8 Multiplexer



Cell Cable Connector

The eight cell connectors (one for each channel) are located on the IMX8 front panel, see Figure B-1. Each cell connector is a 9-pin female D-shaped connector. The pin-layout of all eight connectors is identical. The signal assignment for each pin is shown in Table B-1.

Most of the pins in the IMX8 cell connector are switched to pins on the potentiostat connector when the cell is active. Only one pin is not switched: the ground pin. It is always connected to the system potentiostat's (floating) ground.

Table B-1
Cell Cable Connector

Pin	Name	Use
1	Working Sense (WS)	Connected to the working electrode in cases where the system potentiostat uses a differential electrometer. This pin can be left open when the IMX8 is used with a potentiostat that uses a single-ended electrometer.
2	WS Shield	The shield for the working sense input. Left open at the cell end of the cell cable.
3	Working Electrode (WE)	Connected to the working electrode. The cell current flows through this pin.
4	WE Shield	The shield for the working electrode input. Left open at the cell end of the cell cable.
5	Ground	The system potentiostat's ground. It can be used to shield the cell if very low currents need to be measured. Also recommended as a shield for the counter electrode cable.
6	Reference Electrode (REF)	Connected to the reference electrode.
7	REF Shield	The shield for the reference electrode cable. Left open on the cell end of the cell cable.
8	Counter Sense (CS)	With a potentiostat, used to sense the potential of the counter electrode. Allows accurate ZRA mode even with significant cell current through counter lead's resistance.
9	Counter Electrode (CE)	Connected to the cell's counter electrode. The cell current flows through this connection.

Normal Cell Cable Connections

Normally you can use one of Gamry Instruments' standard cell cables to connect each channel's connector to its cell. Gamry supplies cables that are 1.5 m, 4.5 m, or 9 m in length. Special-purpose cables are also available.

The standard cell cable terminates in banana plugs and one pin jack. Table B-2 identifies each terminal of the cable and its connections to the cell.

Table B-2
Normal Cell Cable Connections

Color	Type	Name	Normal Connection
Blue	Banana Plug	Working Sense	Connect to working electrode
Green	Banana Plug	Working Electrode	Connect to working electrode
White	Pin Jack	Reference Electrode	Connect to reference electrode
Red	Banana Plug	Counter Electrode	Connect to counter electrode
Orange	Banana Plug	Counter Sense	Connect to counter electrode
Long Black	Banana Plug	Floating Ground	Leave open or connect to a Faraday shield
Short Black	Banana Plug	Chassis (Earth) Ground	Leave open or connect to a Faraday shield

The working electrode is the specimen being tested. You make two connections to the working electrode. One of the two connections, with the blue banana plug, is used to sense the voltage at the working electrode when

you use the IMX8 with a system potentiostat that includes a differential electrometer. If you are using a system potentiostat with a single-ended electrometer, you may leave this wire disconnected. The green working-electrode connection carries the cell current.

Connect the white pin jack to the cell's reference electrode, generally an SCE or Ag/AgCl reference electrode. Connect the red (and orange) banana plug to the counter or auxiliary electrode.

The longer black lead is connected to the system potentiostat's ground. The shorter black lead is connected to earth ground. In most cases, leave these terminals disconnected at the cell end. When you do so, take care that they do not touch any of the other cell connections.

When you are measuring very small currents, you may find that a metal enclosure completely surrounding your cell (a *Faraday shield*) will significantly lower the current noise caused by AC pickup at the cell. Connect this Faraday shield to both black cell leads.

You can add an alligator clip (provided) to each of the cell connections. The alligator clips simply slide onto the banana plugs. If you need to permanently change the terminations on your cell cable, feel free to remove the existing terminations and replace them with your desired termination.

In a few cases, you may find that you need to modify the cell cable or make a special-purpose cable. By far the easiest changes involve modifying a standard cell cable. If you decide to make your own cables, we recommend that you use coaxial cable for all the cell connections. Connect the shield of the coaxial cable to the pin recommended in Table B-1 on the potentiostat end and leave the shield open on the cell end.

Cell cables longer than 3 meters may result in degraded instrument performance. Increased noise and decreased stability both can occur. However, with most cells, the instrument will work acceptably with an extended cell cable, so our advice is going ahead and try it.

Potentiostat Connector

The IMX8 potentiostat connector is used to connect the IMX8 to the system potentiostat. The pin-layout of this connector is very similar to that of the cell connectors.

Table B-3
Potentiostat Connector

Pin	Name	Use
1	Working Sense (WS)	Only needed if the system potentiostat uses a differential electrometer. Connect this pin to the negative input of the potentiostat's differential electrometer. This pin can be left open when the IMX8 is used with a potentiostat that uses a single-ended electrometer.
2	WS Shield	The shield for the working sense input. Connect to the shield of the potentiostat's working sense lead (if any).
3	Working Electrode (WE)	Connected to the potentiostat's working electrode input.
4	WE Shield	The shield for the working electrode input. Connect to the shield of the potentiostat's working sense lead.
5	Ground	The system potentiostat's (floating) ground.
6	Reference Electrode (REF)	Connect to the reference electrode input on the system potentiostat.
7	REF Shield	The shield for the reference electrode cable. Connect to the shield of the potentiostat's reference lead
8	Counter Sense (CS)	Connect to the potentiostat's counter sense input (if it has one).
9	Counter Electrode (CE)	Connected to the potentiostat's counter electrode lead. Shield this wire with the potentiostat ground.

Connecting the IMX8 to Third-party Potentiostats

The cable required for connection to third-party potentiostats varies with the potentiostat. The following suggestions may help you in constructing the cable.

- In many cases the easiest way to build the cell cable is to modify a cell cable supplied by the potentiostat's manufacturer. Spare cables are generally available.
- Connect each of the electrode connections to its corresponding pin on the IMX8 Potentiostat connector. For example, the potentiostat's working-electrode lead is connected to the IMX8 connector's working electrode pin.
- Most commercial potentiostats use shielded leads for all of the cell connections. If the potentiostat uses shielded wire, use shielded wire for your custom cable. Connect the pins labeled shield (Working Electrode Shield, Reference Shield, etc.) on the IMX8 connector to the corresponding potentiostat cable shield. If there is no shield on the potentiostat's cell lead, you can leave the corresponding shield pin disconnected.
- If the potentiostat does not have a working electrode sense lead, you can leave the working sense pin on the IMX8 open.
- You can ignore the counter sense pin on the IMX8 connector (unless the cable is intended for use with a Gamry Instruments potentiostat). Leave this pin disconnected.

If an Auxiliary A/D connection is required, connect the IMX8's **Potentiostat Aux A/D Input connector** to the corresponding connector on the potentiostat.

Appendix C: Certifications



Declaration of Conformity: No. DOC-2022-CE-IMX8

According to ISO/IEC Guide 22 and CEN/CENELEC EN 45014

Manufacturer's Name and Location:

Gamry Instruments
 734 Louis Drive
 Warminster, PA 18974
 USA

This declaration is for the Gamry Instruments product model: IMX8 Multiplexer
 The declaration is based upon compliance with the following directives:

- EMC Directive 2014/30/EU

The declaration is based upon product compliance with the following standards as defined in report number R-3542P-1 from Retlif Testing Laboratories for EMC testing and analysis and report number RET 17514-01 from Washington Laboratories, Ltd. for safety analysis.

EMC Standards	Title	Class/ Criteria
EN 61326-1:2013; Clause 7.2	Emissions requirements	B
EN 61326-1:2013; Table 1	All methods except Radiated Immunity	
EN 61326-1:2013; Table 3	Radiated Immunity only	

General Safety Standard	Title
IEC 61010-1:2010 IEC 61010-1:2010/AMD1:2016	Safety requirements for electrical equipment for measurement, control, and laboratory use, Part 1: General requirements



Signature

July 20, 2022
 Date

Dr. Gregory A. Martinchek, PhD
 Title: President

Formal signed declaration is on file at Gamry, Inc.

Certificate of Conformance



**CERTIFICATE OF CONFORMANCE
EUROPEAN COMMUNITY
COUNCIL DIRECTIVE 2014/30/EU**

Date of Issue: May 2022

Issued By: Retlif Testing Laboratories
3131 Detwiler Road
Harleysville, PA 19438

Issued To: Gamry Instruments
734 Louis Drive
Warminster, PA 18974

Reference: Retlif Report Number R-3542P-1

Retlif Testing Laboratories hereby acknowledges that compliance testing in accordance with the below listed standards was performed on a representative sample of the equipment listed below. Retlif Testing Laboratories further acknowledges that the test sample listed below was found to be in compliance with these standards.

This certificate is hereby issued to the above-named grantee and is valid only for the equipment identified below.

Manufacturer: Gamry Instruments
734 Louis Drive
Warminster, PA 18974

Equipment Tested: Electrochemical Multiplexer

Part Number: 992-00189

Model Number: IMX8

Serial Number: IMX-01003

Brand Name: Gamry Instruments

Product Type: Measurement, Control Equipment and Laboratory Use

Note(s): 1) See attached report R-3542P-1 for details and/or conditions pertaining to this certificate.
2) Conforms to the emissions requirements of:
EN 61326-1:2013; Clause 7.2, Class B
3) Conforms to the immunity requirements of:
EN 61326-1:2013; Table 1 (All methods except Radiated Immunity)
EN 61326-1:2013; Table 3 (Radiated Immunity Only)



Declaration of Conformity: No. DOC-2022-UKCA-IMX8

According to ISO/IEC Guide 22 and CEN/CENELEC EN 45014

Manufacturer's Name and Location:

Gamry Instruments
 734 Louis Drive
 Warminster, PA 18974
 USA

This declaration is for the Gamry Instruments product model: IMX8 Multiplexer
 The declaration is based upon compliance with the following directives:

- EMC Directive 2014/30/EU

The declaration is based upon product compliance with the following standards as defined in report number R-3542P-1 from Retlif Testing Laboratories for EMC testing and analysis and report number RET 17514-01 from Washington Laboratories, Ltd. for safety analysis.

EMC Standards	Title	Class/ Criteria
EN 61326-1:2013; Clause 7.2	Emissions requirements	B
EN 61326-1:2013; Table 1	All methods except Radiated Immunity	
EN 61326-1:2013; Table 3	Radiated Immunity only	

General Safety Standard	Title
IEC 61010-1:2010 IEC 61010-1:2010/AMD1:2016	Safety requirements for electrical equipment for measurement, control, and laboratory use, Part 1: General requirements

Signature

July 20, 2022
 Date

Dr. Gregory A. Martinchek, PhD
 Title: President

Formal signed declaration is on file at Gamry, Inc.

Appendix D: Comprehensive Index

- AC adapter, 7, 8
- AC line cord, 8
- AC mains, 8
- active cell, 14, 15
- Auto Update All, 26
- CE Compliance, 12, 21
- cell, 15, 16, 17
- cell cable, 14, 16, 17, 20, 36, 38
- Cell Cable connector, 20, 35
- channel, 15, 16, 33, 35, 36
- channel schematic, 15
- cleaning, 11
- computer, 14, 15, 16, 27, 29
- computer requirements, 21
- contact, 8
- contract engineering, 3
- conventions
 - notational, 17
- Counter Electrode, 17, 36, 38
- Counter Sense, 36, 38
- current carrying, 16
- current switching, 16
- Declaration of Conformity, 39, 41
- earth ground, 8, 17, 36
- electrical transients, 11
- enclosed space, 10
- environmental limits, 10, 34
- environmental stress, 10
- Faraday shield, 36, 37
- firmware update, 25
- floating ground, 35, 36, 38
- floating ground binding post, 9
- Framework software, 19, 23, 26, 27, 29
- Gamry Framework, 13
- GIM, 24, 25, 27
- ground, 17, 35, 36, 38
- grounding, 9
- Help system, 13
- inactive cell, 14, 15, 16
- inactive mode, 15, 16, 17
- inspection, 7, 19
- Instrument Manager, 24, 25, 27
- interface cable, 20
- line cord, 8, 9
- local potentiostat, 15, 17, 33
- noise, 37
- open circuit, 17
- operation, 10
- pairing, 26, 28
- pin-layout, 20, 21, 35, 37
- potentiostat, 13, 14, 15, 16, 17, 27, 29, 35, 36, 37, 38
- Potentiostat connector, 20, 35, 37, 38
- power brick, 7, 8
- Power LED, 25
- power line transient, 11
- radio frequency, 11
- Reference Electrode, 17, 36, 38
- RFI, 11
- RoHS Compliance, 12
- safety, 7
- Select and Update, 26
- service, 11
- service contract, 3
- shielding against noise, 9
- specifications, 33
- static electricity, 11
- storage, 10
- support, 3, 8, 10, 12, 20, 21, 26
- system potentiostat, 14, 15
- telephone assistance, 3
- temperature, 10
- USB, 14
- USB cable, 22
- USB LED, 22
- ventilation, 10, 19
- visual inspection, 19
- Warranty, 3
- Windows, 4
- Working Electrode, 17, 36, 38
- Working Sense, 36, 38
- ZRA, 13, 15, 17, 36