



# Echem Analyst™ Software

Echem Analyst™ Software.....	1
Introduction to This Guide .....	2
General Information and Overview .....	3
Installation .....	3
File Formats .....	3
To Open a Gamry Data File.....	3
Working with Plots in Echem Analyst.....	5
Changing the Axes on a Plot (the <i>Curve Selector</i> ): .....	8
Selecting Portions of a Curve for Analysis.....	8
Selecting Portions of a Curve for Analysis.....	9
Cutting and Pasting Images and Data.....	10
To Get On-Line Help:.....	11
<i>Common Tools</i> and Tabs .....	13
Accessing <i>Common Tools</i> .....	13
List of <i>Common Tools</i> .....	13
Experimental Setup.....	15
Experimental Notes.....	16
Hardware Settings.....	17
Open Circuit Voltage (Corrosion Potential) Data.....	19
Analysis of Cyclic Voltammetry Data.....	20
Cyclic Voltammetry Special Tools .....	20
Integrating the Voltammogram.....	22
Modeling Polarization Resistance Data .....	24
Polarization Resistance Special Tools .....	24
Finding the Polarization Resistance .....	24
Modeling Potentiodynamic (Tafel) Data.....	26
Tafel Fit.....	26
<i>E Log I</i> Fit .....	27
Modeling EIS Data.....	28
Bode and Nyquist Plot View .....	28
EIS Special Tools .....	29
Fitting the Data to the Equivalent-Circuit Model .....	33
Appendix.....	36
Headings in Data-File Columns.....	36
Current Conventions According to Framework™ and Echem Analyst.....	37
To Edit Visual Basic Scripts:.....	37
Simulating an EIS Curve .....	38
Index.....	40

Windows®, Excel®, and Powerpoint® are registered trademarks of Microsoft Corporation. Origin® is a registered trademark of OriginLab Corporation. DigiSim® is a registered trademark of Bioanalytical Systems, Inc. Contents of this manual copyright © 2011 by Gamry Instruments.

# Introduction to This Guide

---

The Echem Analyst™ is Gamry's dedicated data-analysis program, the companion to Gamry's data-acquisition program called Framework™. Data files generated by experiments in Gamry Framework then can be analyzed in the Echem Analyst. The Echem Analyst is a single program that runs data-analysis for all types of experiments, such as those used in DC Corrosion, EIS and Physical Electrochemistry.

The Echem Analyst is designed with the specific functions to make data analysis as straightforward as possible. This manual will explain the most common analysis routines. The tools discussed here in the examples are common to many data files created by other experiments. This document is a guide, and is not intended to have the same scope as the on-line help or a complete operating manual. In order to create a concise document, we assume the user has a working knowledge of Windows®-based applications. Details on common functions, such as opening, saving, and closing files, are intentionally ignored, so as not to obscure the goal of this guide.

This textbox indicates a helpful hint to know about Echem Analyst.



# General Information and Overview

---

## Installation

Echem Analyst installs separately from other Gamry software. If Echem Analyst is not installed yet, you can find it on the CD-ROM, or—if you already own one of our potentiostats—on our website at [www.gamry.com](http://www.gamry.com).

You may install copies of the Echem Analyst on multiple computers. Often users prefer the convenience of performing data-analysis at an office workstation, rather than the laboratory setting.

## File Formats

Gamry data files acquired using Framework software have the extension \*.DTA. DTA files are ASCII text, and therefore may be opened directly into various programs, such as Excel® or Origin®. When DTA files are opened in Echem Analyst, then saved, their extension becomes \*.GDatA. Gdata files include information on curve-fits and graphing options, thus Gdata files are only viewable in Echem Analyst.



Do not delete your DTA files! They are the raw data and may need to be reloaded for certain analyses, such as area normalization.

## To Open a Gamry Data File

There are several different methods to open data files in the Echem Analyst:

1. Launch the Echem Analyst icon on your desktop. Then use the *File\Open* function.
2. Use the link on your desktop to open the *My Gamry Data* folder. Double-click on the data file. You may have to instruct your computer to associate the \*.DTA extension with the Echem Analyst program.
3. There are two quick ways to open a recent Gamry Data File.
  - a. A recently generated file can be opened using the hotlink in the *Analysis* menu in the Gamry Framework. (The last eight generated data files are listed there for quick access.) The Echem Analyst automatically launches and opens your selected data file.
  - b. A recently opened file in the Echem Analyst is shown at the bottom of the *File* menu. This is similar to how other Windows®-based programs display links to *Most Recently Used* documents.



By default, files acquired in the Framework are saved into the *My Gamry Data* folder. A shortcut for *My Gamry Data* installs on the Windows® desktop. You can change this default under *Tools\Options*, which opens the **Gamry Analysis Framework Options** window. Choose the *General* tab, and change the *Path* for each type of data file as desired.

 Don't change the directory for *Analysis Script* Files. These are the VBA programs that do the actual analysis.

The data set appears in the main window. The menu items, tabs, and toolbar are adjusted for the particular type of data set you chose. In the example below, a Potentiostatic EIS data set is shown:

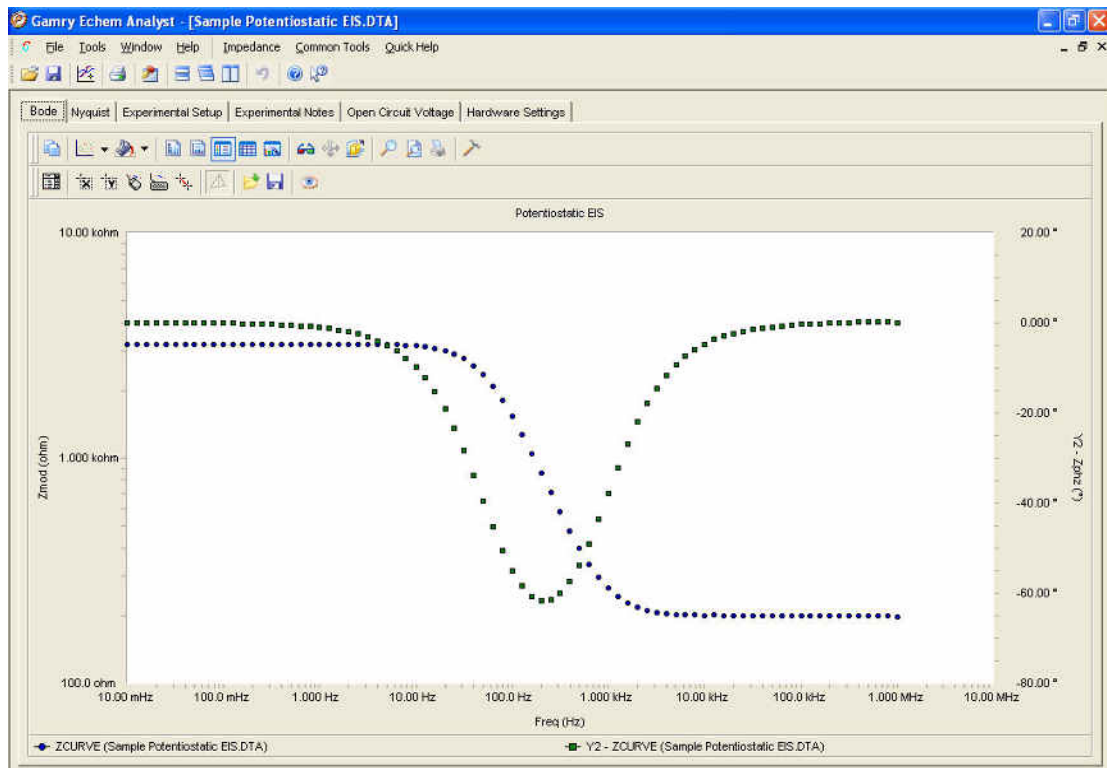

Note the tab-based display. The *Experimental Setup* tab displays all the information from the parameters used to run the experiment, such as Voltage, Time, etc. The *Experimental Notes* tab stores any notes written into the setup screen in Framework. The *Open Circuit Voltage* tab shows the voltage measured during the Initial Delay of the experiment. The *Hardware Settings* tab records information on the filters, ranges, gains. Additional information on date of last calibration, software version, etc. is also stored here.

# Working with Plots in Echem Analyst

## *Introduction*

Echem Analyst boasts a number of graphical tools to help you get the most information out of your data. Once you open a data set, these tools appear in the toolbars immediately above the plot:

In the data file, Framework writes a line that indicates the type of experiment used to generate that file. Echem Analyst displays both general and specific menus containing the analysis routines pertinent to your experiment.

## *Toolbars:*

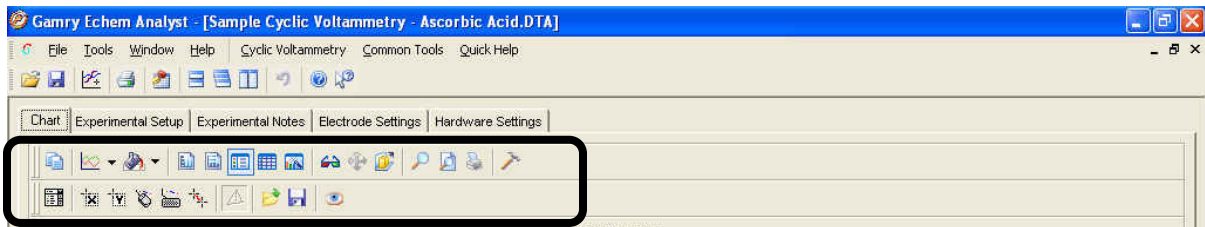

The main toolbars are:

General  
Toolbar

General functions for replotting and printing in various formats







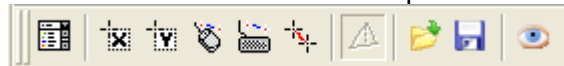









Selection  
Toolbar

Tools to select and view data points













The following charts are references for buttons on the default toolbars. Descriptions of the most commonly used functions are highlighted in blue.

## General Toolbar *Functions*

Button	Name	Action
	Copy to clipboard	Copy the selection to the Windows® clipboard. Can paste directly in Microsoft programs for reports or presentations.
	Gallery	Choose, via the dropdown menu, from scatter (no line), line, curve, and steps between data points
	Color	Choose the color of the selection from the dropdown menu. To change the color menu, use the <i>Palette</i> button on the <i>PaletteBar</i> .
	Vertical Grid	Toggle between showing and hiding vertical grid lines on the plot
	Horizontal Grid	Toggle between showing and hiding horizontal grid lines on the plot
	Legend Bar	Toggle between showing and hiding a legend bar underneath the plot
	Data Viewer	Toggle between showing and hiding numerical data to the left of the plot
	Properties...	Open the <b>GamryChart Properties</b> window, so that you can adjust effects, colors, markers, 3-D effects, lines, etc.
	3D/2D	Toggle between two-dimensional and three-dimensional graphing
	Rotate	Rotate the three-dimensional graph. Only active if the graph is 3D.
	Z-clustered	Offset two data sets so that they can be distinguished within one plot. Only operates in 3D mode.
	Zoom	Zoom in on a selected region. Also open a zoom slider at the bottom of the graph for continuous adjustment of zoom.
	Print preview	Open the <b>Page setup</b> window to adjust orientation of plot and printer margins
	Print	Print the plot
	Tools	Open a dropdown menu, for choices of various toolbars and viewers to appear on the screen

## Selection Toolbar *Functions*

Button	Name	Action
	Show curve selector	Open the Curve Selector area to the right of the plot, so that you can choose which data are used as the x-, y-, or y2-coordinate, and which curve is the active trace.
	Select x region	Select a desired region of the plot across the x-axis. Commonly used to specify a region for <i>Quick-Integrate</i> .
	Select y region	Select a desired region of the plot across the y-axis. Commonly used to specify a region for <i>Quick-Integrate</i> .
	Select Portion of Curve using the Mouse	Left-click on the active trace using the mouse to select a section of the curve
	Select Portion of Curve using the Keyboard	Open an area to the right of the plot, in which you can choose a segment of the trace numerically. See below for more details.
	Draw Freehand Line	Draw a line on the plot
	Mark Found Peaks	Place a tag on peaks that the software finds. A portion of the curve must be selected first.
	Apply Template	Open the <b>Apply User-Defined Chart Template</b> window, and choose a previously created template to apply to the plot
	Save Template	Open the <b>Save User-Defined Chart Template</b> window, and save the template
	Show Disabled Points	Show data points not being used in the plot

## Changing the Axes on a Plot (the *Curve Selector*):

To choose a different variable plotted on an axis, use the *Curve Selector* button



as follows:

(The example shown below is a Differential Pulse Voltammetry plot.)

1. With the plot open and displayed on the screen, click the *Curve Selector*

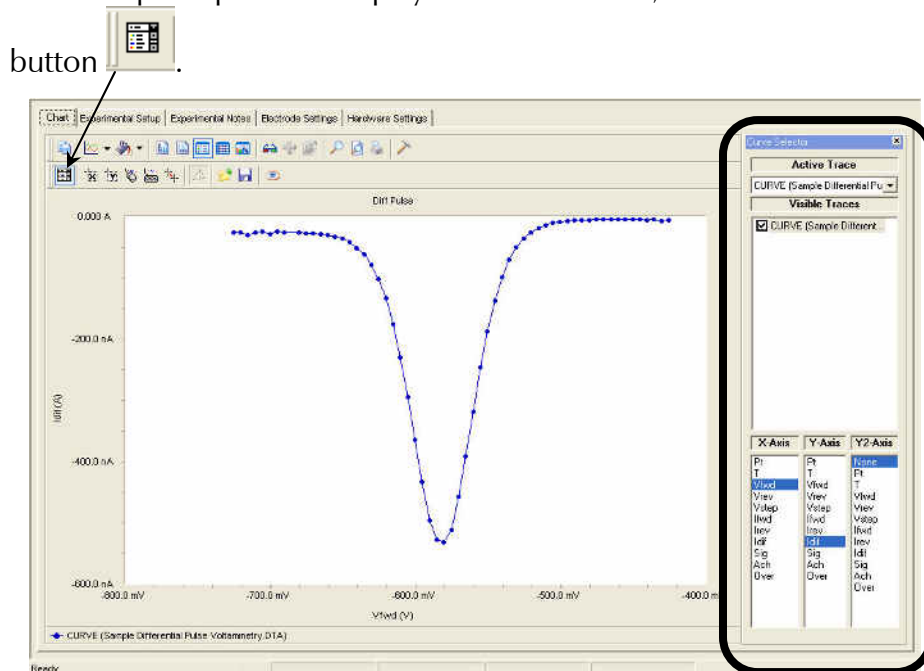

The *Curve Selector* area appears on the right side of the window.

2. Choose which trace is active by clicking on the drop-down menu in the *Active Trace* area.

The Active Trace is the data series on which the analysis will be performed.

Use this, for example, if multiple files or cycles are displayed on the graph.

3. Choose which trace is visible on the plot by activating the checkbox next to the desired trace(s) in the *Visible Traces* area.

*Visible Traces* also contain any data fits that are performed.

4. Choose which variable is plotted on the x-axis by highlighting the variable in the X-Axis column.
5. Choose which variable is plotted on the y-axis by highlighting the variable in the Y-Axis column.
6. Choose which variable is plotted on the second y-axis by highlighting the variable in the Y2-Axis column.



If there is a data column graphed on the Y2-Axis, those data appear in a different color and a different scale.



## Selecting Portions of a Curve for Analysis

For certain types of analysis, you must select a region of the curve, for example, within the *Peak Find* function in *Cyclic Voltammetry* or *Tafel Fit* function in *Potentiodynamic*. You can select regions by mouse or keyboard.

1. Left-click the mouse on the *Mouse* button  in the *Selection toolbar*.
2. Use the left mouse-button to select each endpoint of the curve. Each endpoint is marked with a blue cross. The selected portion of the curve is shown as a thick blue line. (In the figure below, the color of the data has been changed to red for contrast to the selected region).

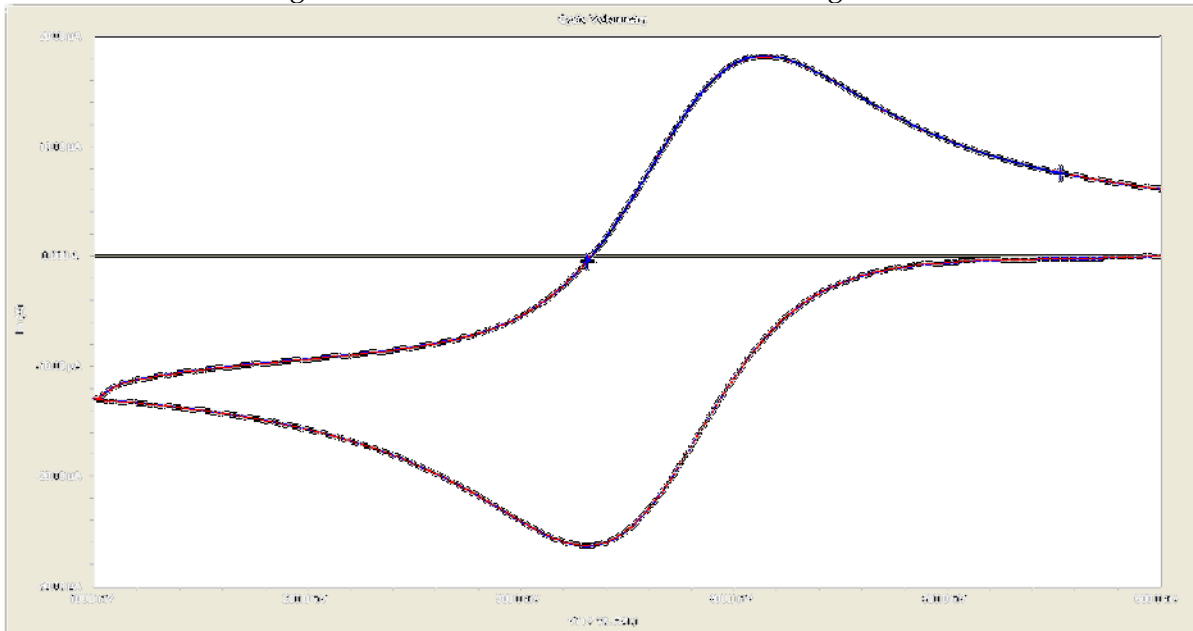

3. Another click on the *Mouse* button clears the selected region, and readies the graph for a different region to be selected.

## Cutting and Pasting Images and Data

Many users want to present, publish, or otherwise share their data and charts from the Echem Analyst. To create a bitmap image of the graph,

### ***As a Bitmap:***

1. Choose the *Copy to Clipboard* button  from the *General Toolbar*.
2. In the drop-down menu select *As a Bitmap*.

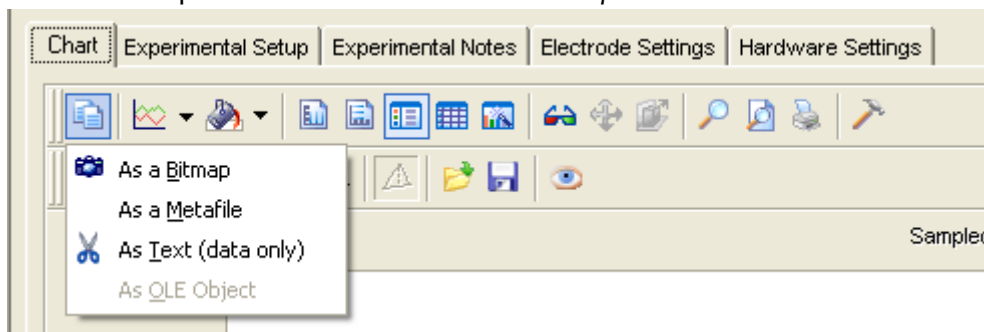

3. A bitmap image of the graph enters the clipboard. This bitmap may be pasted into a presentation program such as Word® or Powerpoint®.

This is a quick and easy way to import a picture of the graph for a presentation or report.

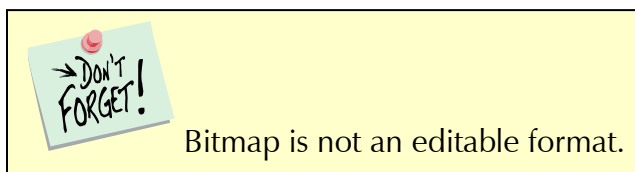

### ***As Text:***

Because Gamry Data Files are ASCII text, they can be opened easily in other graphing programs, such as Excel® or Origin®. Right-click on the DTA file and select *Open With...* and select for favored program. These programs, however, do not contain fitting routines specific to the analysis of electrochemical data. This *As Text* feature lets you fit the data in Echem Analyst and then copy and paste the data and fit into another graphing program.

This is a quick and easy way to import both the data and the fit into another graphing program.

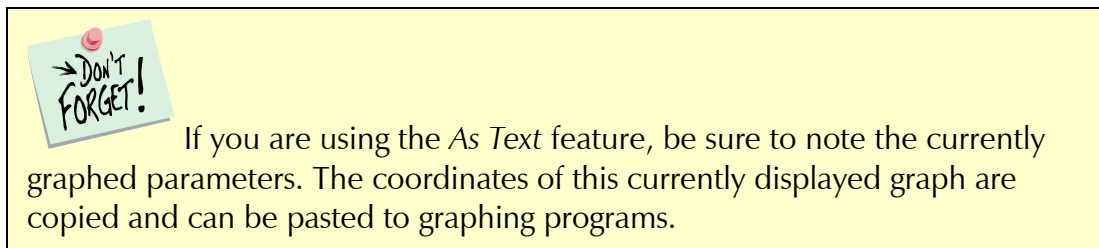

## Plotting Conventions

By right-clicking the mouse on a non-zero value on an axis, you can choose to show that axis in logarithmic or linear scale, or to reverse the direction of the numbers.

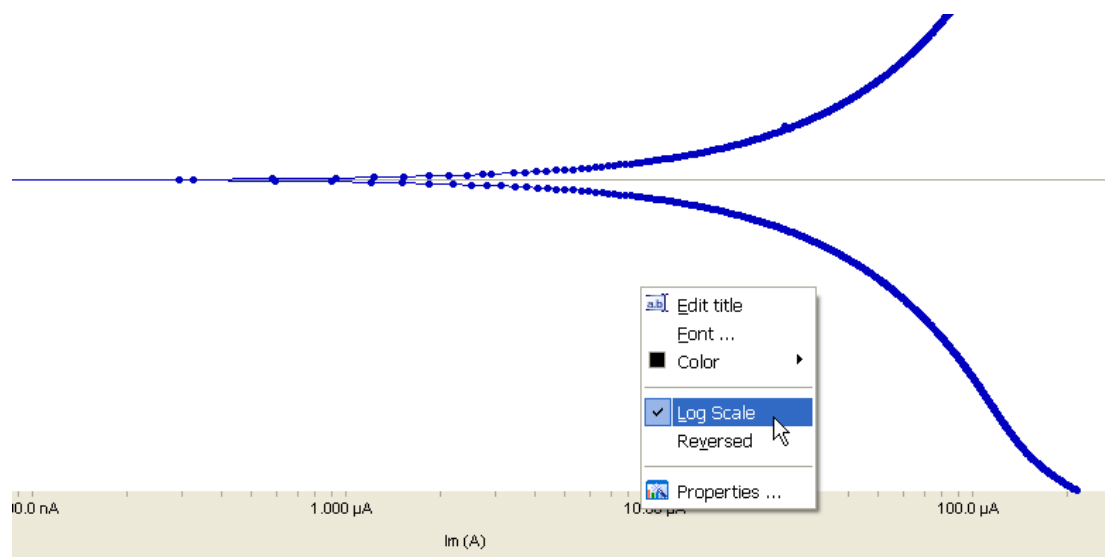

Alternatively, you can use the *Transform Axes* selection (if available) under the *Common Tools* menu.



Default plotting of graphs is auto-scale. Therefore, please note the y-axis's scale when a plot first appears. If bad data points obscure your data because of auto-scaling, you can choose to disable and hide those offending points.

## To Get On-Line Help:

In the toolbar, choose *Help*.

- Click *Gamry Help* to obtain information about various commands and functions within Echem Analyst.

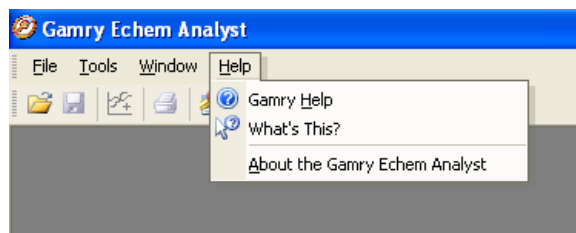

A separate **Gamry Echem Analyst Help**

window appears. You can find much information about the details of Echem Analyst here, such as plotting and analysis.



On-line help is a great resource for more involved questions. Help is divided up according to software package.

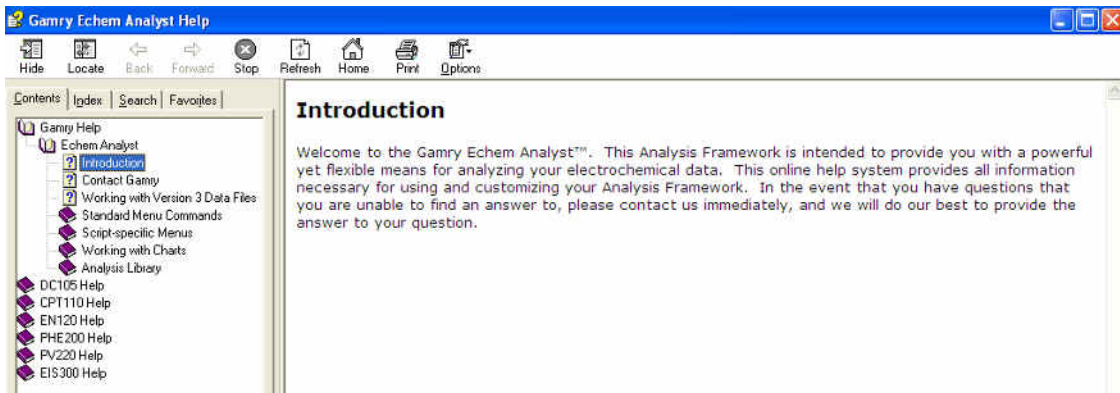

- b. Click *About the Gamry Echem Analyst* to view the software version number.

# Common Tools and Tabs

While each type of experimental data has its own method and parameters, there are certain commands that are common to many analyses. This section shows you these *Common Tools*.

## Accessing *Common Tools*

1. Open a dataset.

In the toolbar, the function *Common Tools* appears.

2. Choose *Common Tools*.

A drop-down menu appears.

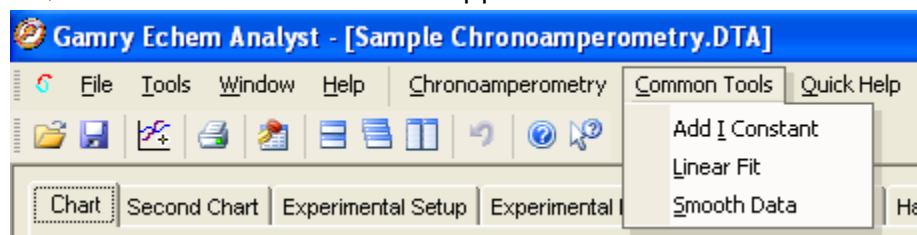

3. Select the desired command.

In this example, chronoamperometry's *Common Tools* includes three commands, *Add I Constant*, *Linear Fit*, and *Smooth Data*.



The list of *Common Tools* varies depending upon the type of experiment.

## List of *Common Tools*

Command	Type of experiment	Result
Add E Constant	Cyclic Voltammetry, DC Voltammetry, Differential Pulse Voltammetry, Galvanic Corrosion, Normal Pulse Voltammetry, Pitting Scan, Polarization Resistance, Potentiodynamic Scan, Square-Wave Voltammetry	Adds a constant potential to all voltages in the plot. Used to easily convert between different Reference Electrode's scales.
Add I Constant	Chronoamperometry, Chronopotentiometry, Cyclic Voltammetry, Galvanic Corrosion, Pitting Scan, Polarization Resistance, Potentiodynamic Scan	Adds a constant value to all currents in the plot.
C from CPE, omega(max)	Potentiostatic EIS, AC Voltammetry, Mott-Schottky	Calculates capacitance from previously fit CPE values and data

C from CPE, R(parallel)	Potentiostatic EIS, AC Voltammetry, Mott-Schottky	from the Nyquist plot. Calculates capacitance from previously fit CPE and fit R data.
Linear Fit	Chronoamperometry, Potentiostatic EIS, AC Voltammetry, Chronocoulometry, Chronopotentiometry, Cyclic Voltammetry, DC Voltammetry, Differential Pulse Voltammetry, EMF Trend, Galvanic Corrosion, Mott-Schottky, Normal Pulse Voltammetry, Polarization Resistance, Potentiodynamic Scan, Square-Wave Voltammetry	When a region of the plot is selected, fits the data to $y = mx + b$ .
Post-Run $iR$ Correction	Cyclic Voltammetry, Polarization Resistance, Potentiodynamic Scan	Corrects a previously run scan for voltage-drop caused by $iR$ .
Smooth Data	Chronoamperometry, Chronopotentiometry, Cyclic Voltammetry, DC Voltammetry, Differential Pulse Voltammetry, EMF Trend, Galvanic Corrosion, Normal Pulse Voltammetry, Pitting Scan, Polarization Resistance, Potentiodynamic Scan, Square-Wave Voltammetry	Smooths the data. Useful for locating peaks in regions of high data-density.
Transform Axes	Galvanic Corrosion, Pitting Scan, Polarization Resistance, Potentiodynamic Scan	Changes x- and y-axes from linear to logarithmic, etc.

---

# Experimental Setup

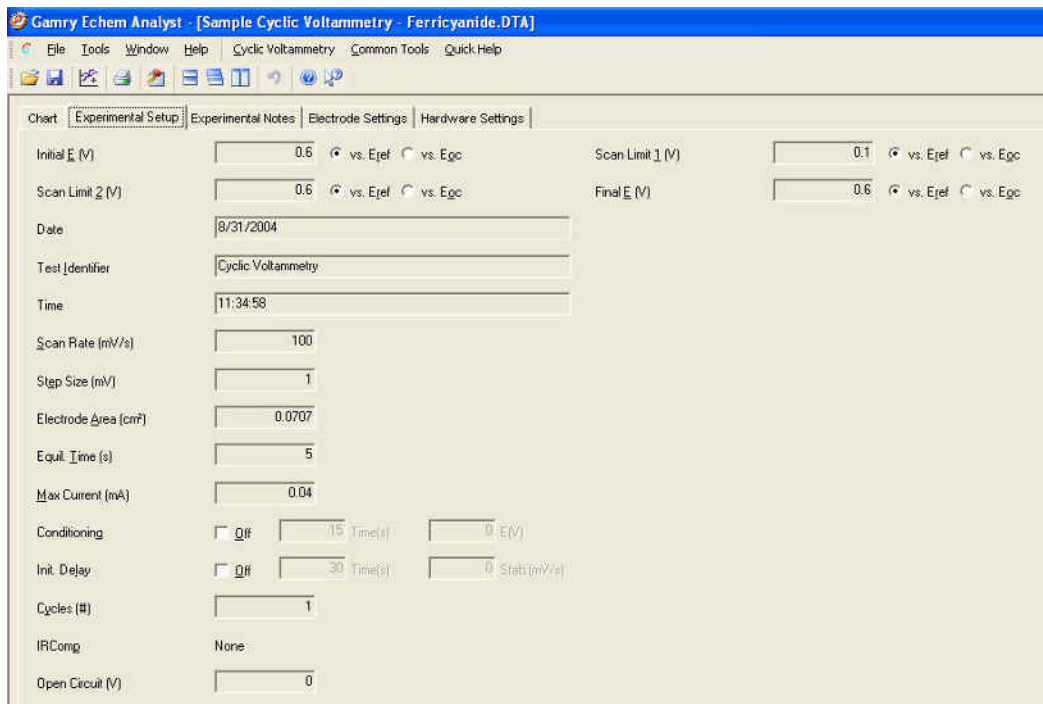

This particular *Experimental Setup* tab is from a Cyclic Voltammetry experiment. This example has many of the same parameters as other experiments. It shows:

Initial E, Scan Limit 1, Scan Limit 2, Final E	The potentials defining the waveform, and whether measured vs. a reference electrode ( $E_{ref}$ ) or the open circuit potential ( $E_{oc}$ ).
Test Identifier	Read from the Framework Setup. This field also becomes the default title of the plot.
Time	Time the experiment was started
Scan Rate	How fast (in mV/s) the scan was taken
Step Size	The interval between potentials
Electrode Area	The size of the electrode
Equil. Time	How much time was spent letting the electronics settle before the scan was started
I/E Range Mode	Automatically adjusted or fixed I/E (Current) Range mode.
Max Current	The current value that sets the I/E Range in Fixed Mode and determines the range in which to start in Auto Mode
Conditioning	Whether off or on, for how long, and under what potential. This Potential is vs. Reference.
Init. Delay	Whether off or on. This is when the $E_{oc}$ is measured.
Cycles	Number of how many voltammetry cycles were run
IR Comp	If IR Compensation was used and the mode.
Open Circuit	The value of the Open circuit voltage (Corrosion Potential). It is the value of the last point in the Initial Delay.
Sampling Mode	Data-acquisition mode (for Reference Family Potentiostats)

## Experimental Notes

Click the *Experimental Notes* tab:

Any notes entered in the Framework are automatically displayed here. You may enter any additional comments about the experiment in the *Notes...* field.

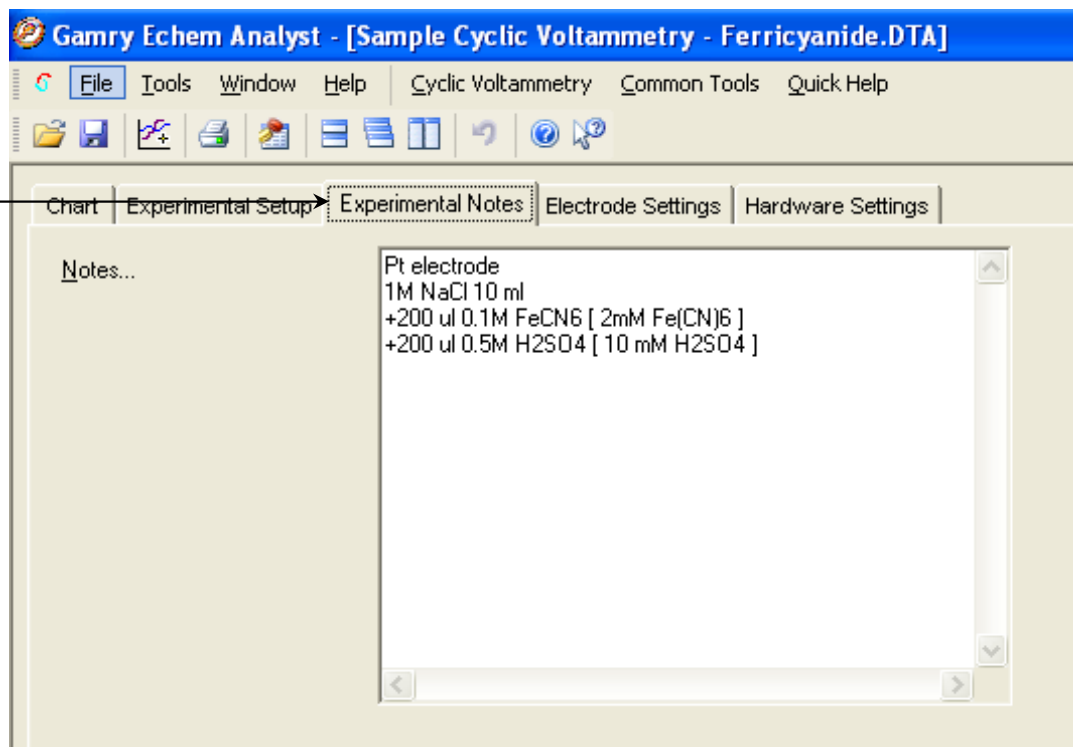

This is a version of a modern laboratory notebook. Enter as many details about your experiment as you can. Information here can help you avoid having long strings of descriptive file names.





DC Calibration Date	Shows the date of last DC calibration
Framework Version	
Pstat Model	Gives the model number of the potentiostat
Current Convention	Shows which currents are positive
I/E Stability	Shows the I/E stability speed
I/E Range	Shows the I/E (or current) range used
Vch AutoRange	Shows if $V_{ch}$ autoranging is enabled
Vch Range	Shows the maximum value for $V_{ch}$
Vch Filter	Shows the $V_{ch}$ cut-off filter frequency
Vch Offset Enable	Shows if $V_{ch}$ Offset was enabled
Vch Offset	Shows the $I_{ch}$ offset voltage
Positive Feedback Resistance	Shows the positive feedback resistance applied to the system
Ach Range	Shows the voltage range of the auxiliary channel
Cable ID	(for Reference Family Potentiostats only.) Gives the type of cable connected to the system
AC Calibration Date	Shows the date of last AC calibration
Instrument Version	Shows the Firmware Version of a Reference Family Pstat

Detailed explanations of these parameters are beyond the scope of this guide.

# Open Circuit Voltage (Corrosion Potential) Data

Click the *Open Circuit Voltage* tab:

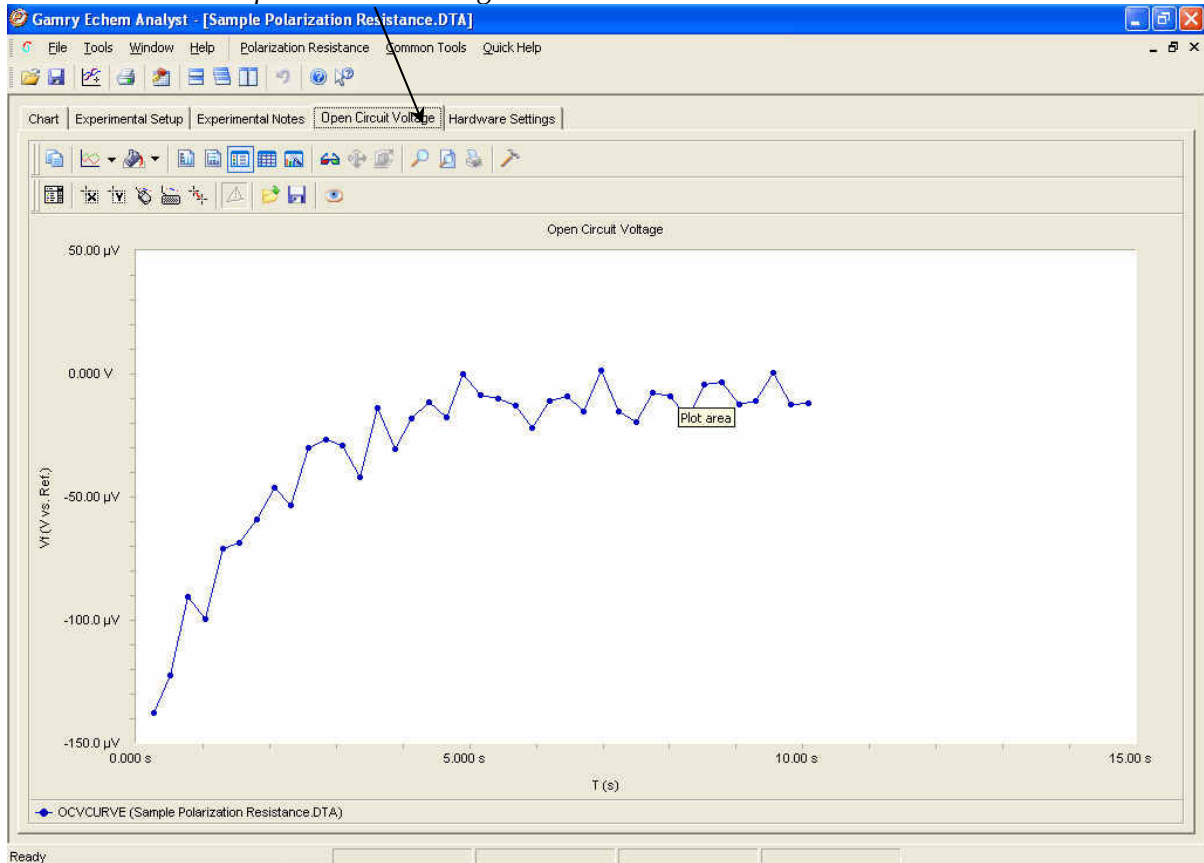

Because default plotting of graphs is auto-scale, please note the y-axis's scale when the *Open Circuit Voltage* first appears.

# Analysis of Cyclic Voltammetry Data

This is a sample cyclic voltammetry file that installs in `\My Gamry Data\` when Framework installs.

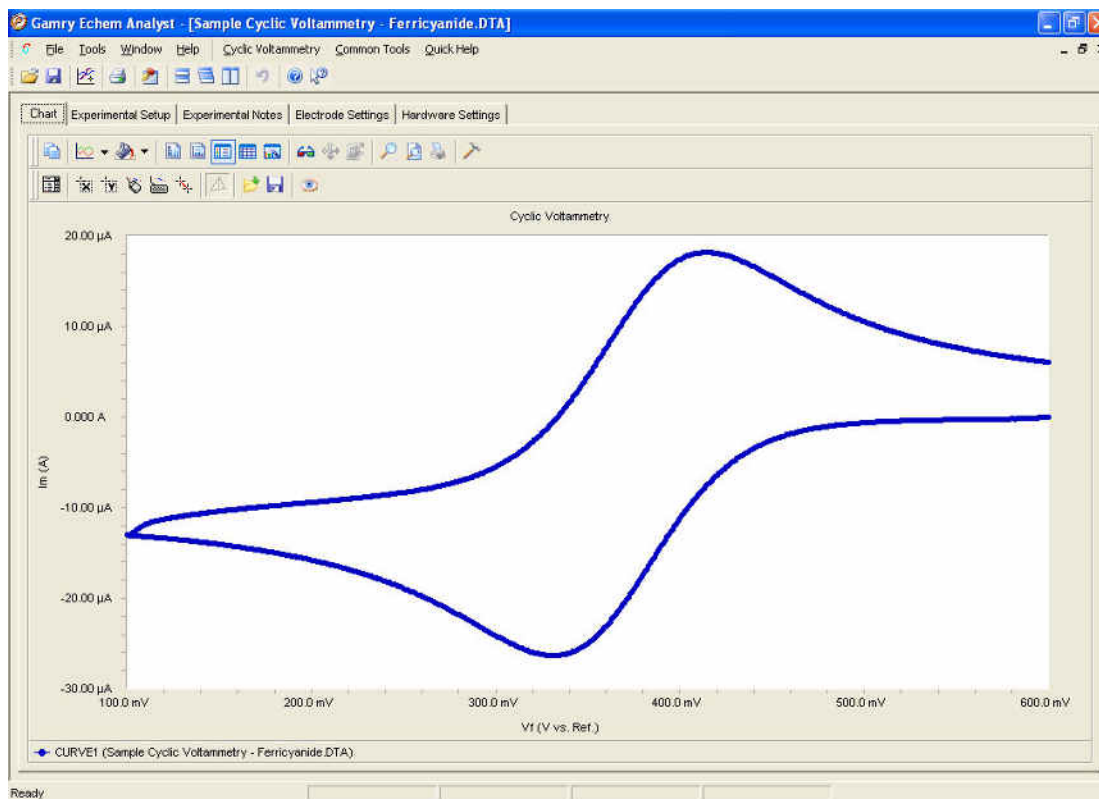

## Cyclic Voltammetry Special Tools

This menu analyzes the cyclic voltammetry data.

1. In the main menu, choose *Cyclic Voltammetry*.  
A drop-down menu appears.
2. Choose the desired tool:

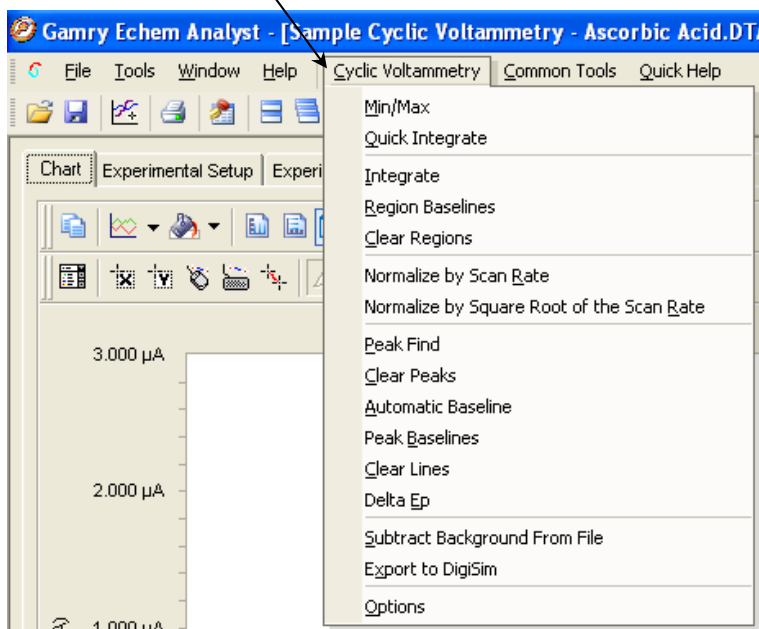

<b><i>Tool</i></b>	<b><i>Function</i></b>	<b><i>Notes</i></b>
Min/Max	Finds the minimum and maximum currents and voltages within the dataset. Results appear in a window below the plot.	
Quick Integrate	Integrates to find the total charge. Results appear in a window below the plot.	For multi-cycle CV experiments
Integrate	Integrates over a specified portion of the plot to find the total charge.	Portion of the curve must be selected
Region Baselines	Defines a line as the baseline for a specified region.	Region must be selected
Clear Regions	Clears all baselines from the dataset.	Region must be selected
Normalize by Scan Rate	Normalizes the dataset based on the scan rate.	
Normalize by Square Root of the Scan Rate	Normalizes the dataset based on the square-root of the scan rate.	
Peak Find	Finds peaks within a specified region of the dataset.	Portion of the curve must be selected
Clear Peaks	Clears all peaks found within the dataset.	Peaks must be identified
Automatic Baseline	Finds the baseline automatically.	Peaks must be identified
Peak Baselines	Defines a line as a baseline for a specified peak.	Peaks must be identified
Clear Lines	Clears all lines from the dataset.	Lines must be associated with graph
Delta Ep	Finds the potential difference between two peaks.	Peaks must be identified
Subtract Background from File	Subtracts a background amount from the dataset.	
Export to DigiSim	Exports the file to a DigiSim <sup>®</sup> -compatible format.	
Options	Changes units and grids for plotting the data.	

# Integrating the Voltammogram

All integration methods integrate current versus time to get the total charge. There are two different ways to integrate under a curve with Echem Analyst.

## Quick Integrate

*Quick Integrate* breaks the data into “curves”. Each curve is integrated to a zero current. *Quick Integrate* integrates the entire area of each curve, unless an area is specified using the x-region icon.

## Integrate

*Integrate* requires you first to select a portion of the curve. (See how to select a portion of the curve in the “Starting Echem Analyst” chapter.) After an integration is performed, you can change the baseline from the default 0 A to another line, either a line that you draw, or an *Automatic Baseline*.

1. Open the data file.
2. Select the *Draw a Freehand Line* button:

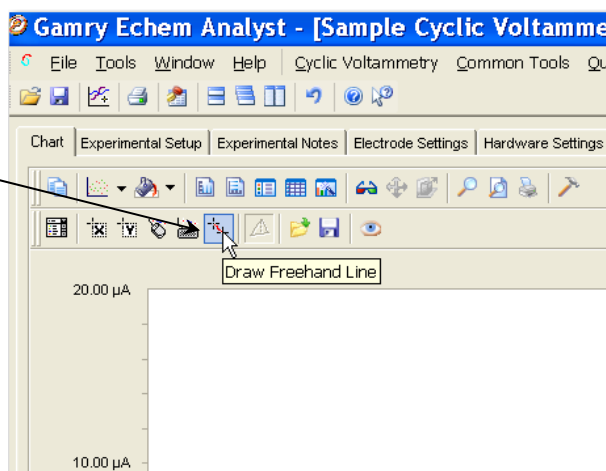

3. Left-click and hold on the graph to place an anchor point. Holding down the mouse button, extend the line with the mouse. Move or extend the line as you wish.

Directions to accept the line are printed at the bottom of the window.

4. Right-click the mouse on the line and either *Accept* or *Delete*. After you accept the line, it turns from dashed to solid.
5. Select the portion of the curve to integrate. This function is described in detail earlier.

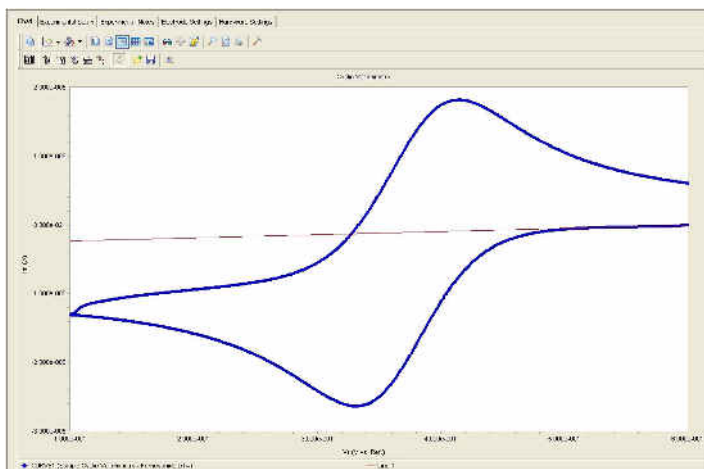

6. Select *Integrate* from the *Cyclic Voltammetry* menu.

This integrates the section between the curve and the zero amp line.

7. To change the baseline to the desired user-drawn line, select *Region Baselines* from the *Cyclic Voltammetry* menu.

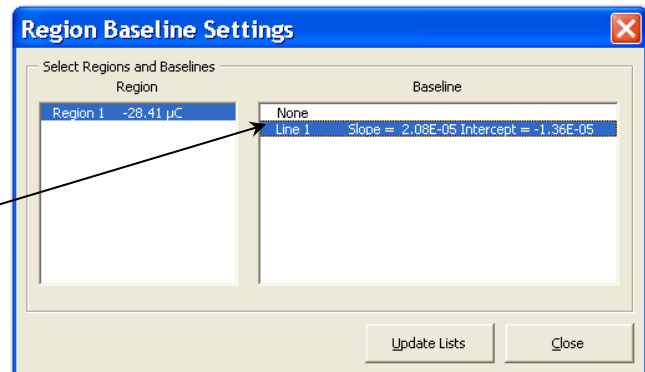
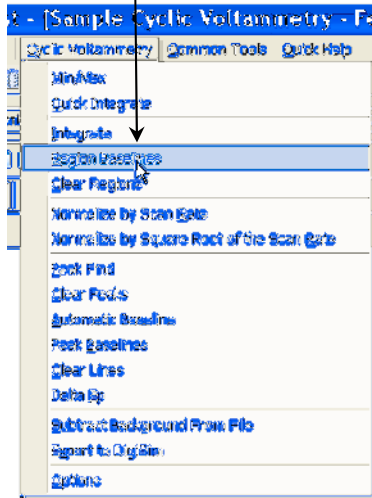
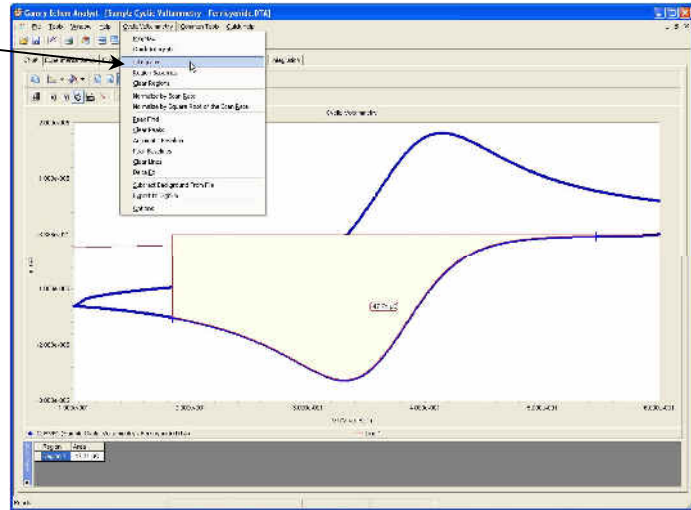

The **Region Baseline Settings** window appears.

8. Select the *Region Baseline* from the available lines. You may draw multiple lines from which to choose.

Note that the integrated region moves from the default 0 Amps baseline to the user-drawn line.

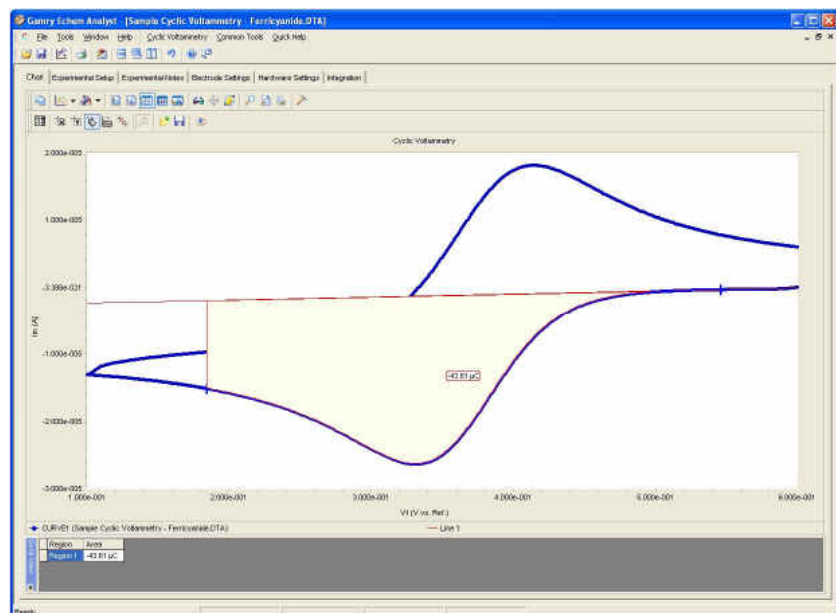

# Modeling Polarization Resistance Data

## Polarization Resistance Special Tools

This menu analyzes the polarization resistance data.

1. In the main menu, choose *Polarization Resistance*.

A drop-down menu appears.

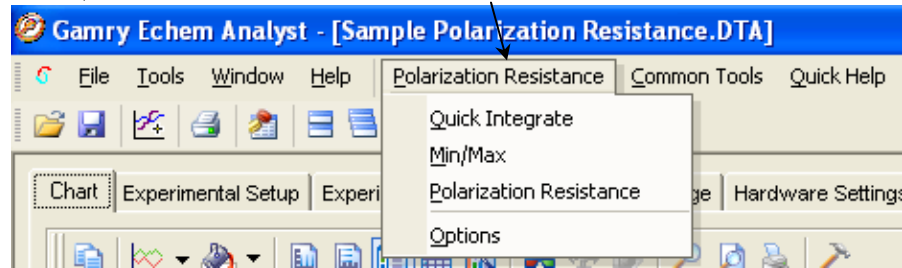

2. Choose the desired tool:

<i>Tool</i>	<i>function</i>
Quick Integrate	Integrates to find the total charge. Results appear in a window below the plot.
Min/Max	Finds the minimum and maximum currents and voltages within the dataset. Results appear in a window below the plot.
Polarization Resistance	Within a selected portion of the curve, finds the polarization resistance.
Options	Changes units and grids for plotting the data.

## Finding the Polarization Resistance

### *Method 1: Manual Entry of the Tafel Constants*

1. Select the desired portion of the curve. (See section....)
2. In the main menu, choose *Polarization Resistance*.

A drop-down menu appears.

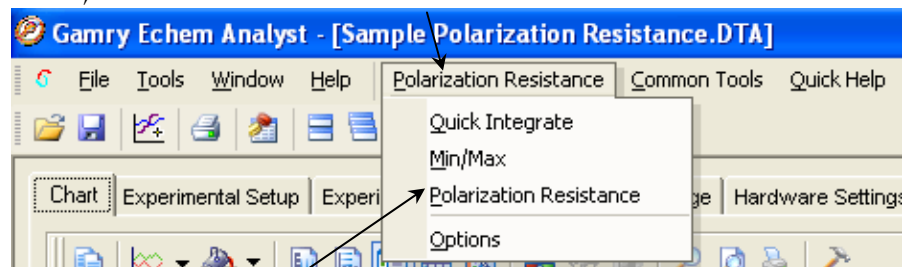

3. Choose *Polarization Resistance*.  
The **Polarization Resistance** window opens.
4. In the *Seed Values* area, enter anodic (*Beta A*) and cathodic (*Beta C*) Tafel constants.
5. Click the *Calculate* button.  
The calculated *Corrosion Rate* appears in a window below the plot.

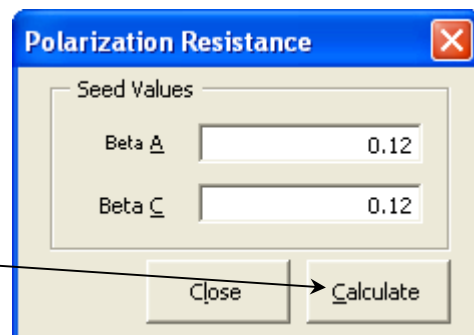



## Method 2: Automatic Selection of Voltage Region

Gamry offers another way to select automatically the voltage region over which this analysis is done.

1. In the *Polarization Resistance* menu, choose *Options*.

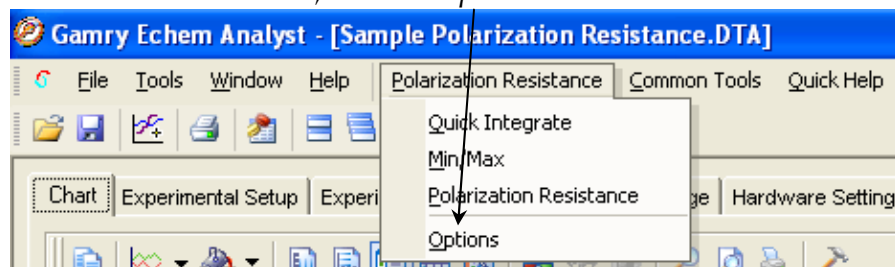

The **Polarization Resistance Options** window opens.

2. Select this *Automatic* radio button, specify the region around  $E_{corr}$  to use, and *Save as Defaults*. You are prompted directly for Tafel constants when a polarization resistance file is opened.

This is how Gamry's RpEc Trend experiments calculate corrosion rate.

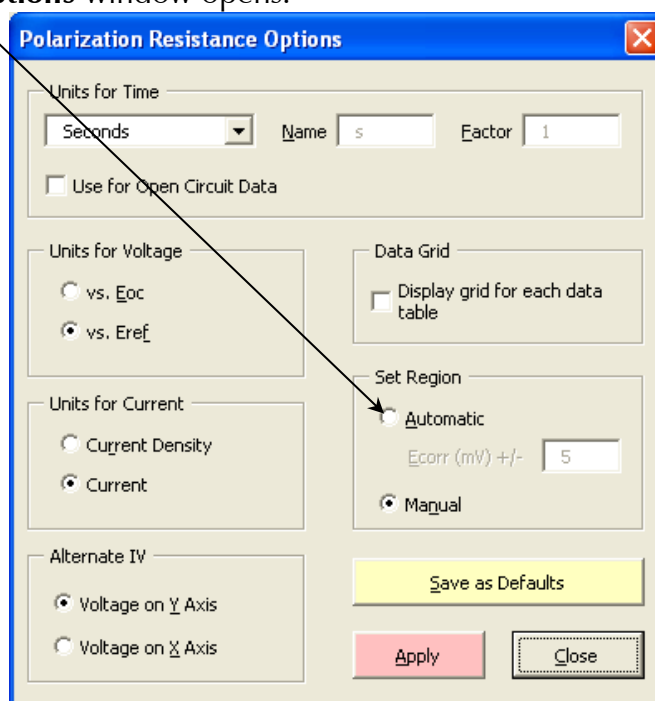

# Modeling Potentiodynamic (Tafel) Data

A Tafel experiment is also a very popular electrochemical corrosion technique. The following analysis is performed on the sample Potentiodynamic data file.

## Tafel Fit

1. Select the region over which to perform the Tafel fit.  
This region must encompass the  $E_{corr}$  (Open Circuit Potential).
2. Select *Tafel Fit* from the *Potentiodynamic* menu:

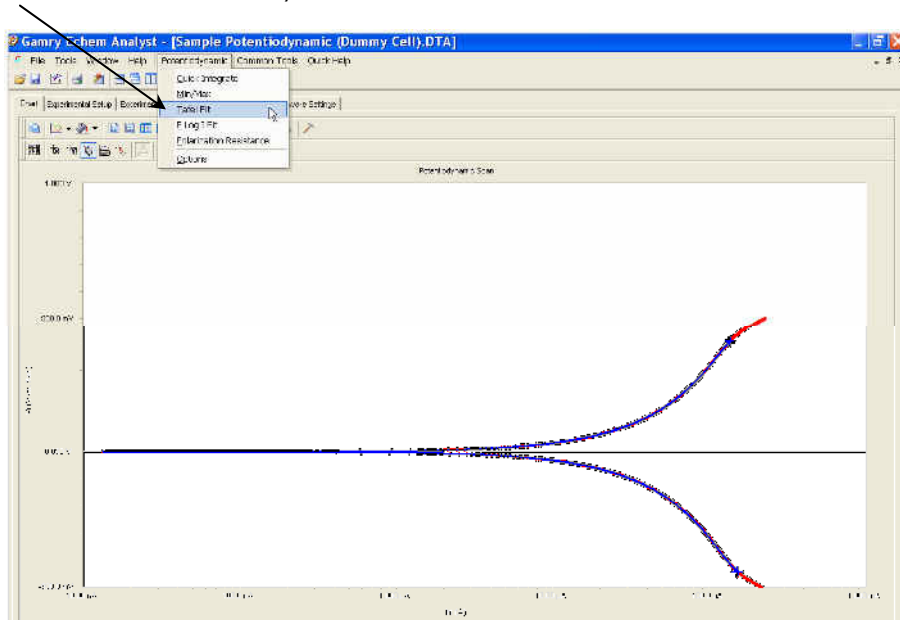

3. A **Tafel Fit** window appears where you may input seed values optionally for the fit. The better the information we provide the fitting routine, the more likely it will be able to generate an acceptable fit.

If you have reasonable starting parameters for the fit, input them in the *Seed Values* area, and check the *Use Seed Values* checkbox. If you do not have any confidence at all in your range of parameters, do not check the *Use Seed Values* checkbox.

We recommend using the seed values supplied by the Echem Analyst.

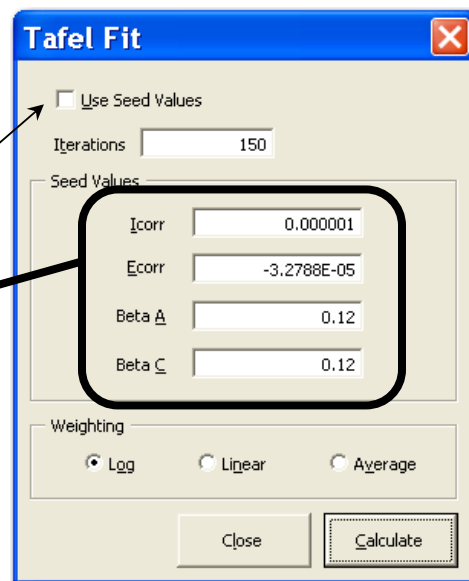

4. Click the *Calculate* button.  
When the *Calculate* button is pressed, the changes can be subtle. The following events occur:
  - The parameters in the **Tafel Fit** window become the fit parameters.

- A fit line is displayed on the graph.
- A new *Tafel* tab is created (to the right of the *Hardware Settings* tab) that holds the information about the fit.

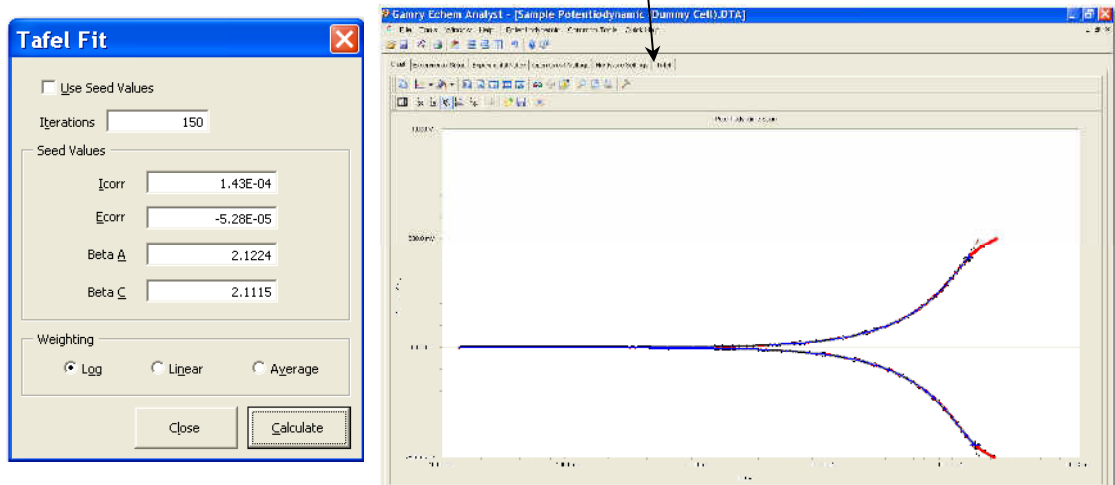

## *E Log I* Fit

The *E Log I* fit is a useful fit if you want to fit the data one branch (anodic or cathodic) at a time. This can be important if one branch doesn't show linear behavior, but the other does.

The fit is called *E Log I* because of the semi-logarithmic nature of a Tafel plot. The x-axis is the logarithm of current, while the y-axis is potential on a linear scale.

### **Method**

1. Select a portion of the curve.  
Here you need only the linear section of one of the branches. This selection does not include  $E_{corr}$  ( $E_{oc}$  (open circuit potential)).
2. In the **E Log I Fit** window, enter an approximate value for  $E_{corr}$ .
3. Click the *Calculate* button.  
A single branch of the Tafel data is fit. The fit is shown on the graph, and the results of the fit are contained in a new *E Log I* tab.

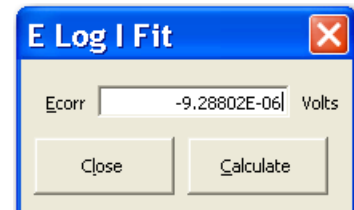

You can run a Polarization Resistance fit on this Potentiodynamic data, if the axes of current are changed to the linear scale. Generally we suggest running a separate experiment on a new sample of the same material because of the more-polarizing, more-destructive nature of the Potentiodynamic experiment.

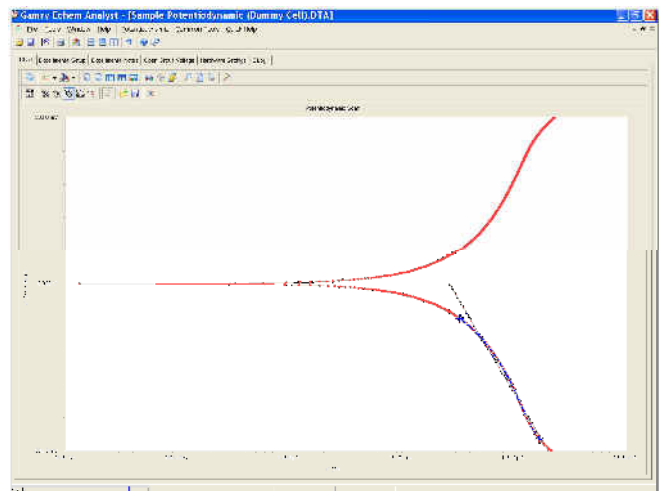

# Modeling EIS Data

The data-analysis features shown here are common to many of the AC-based techniques. By far the most popular type of AC experiment is Potentiostatic EIS.

## Bode and Nyquist Plot View

Click the *Bode* tab or the *Nyquist* tab of the plot you prefer to work with. All fits are displayed on both the Bode and Nyquist plots. Because they are different representations of the same data, the fit results are identical.

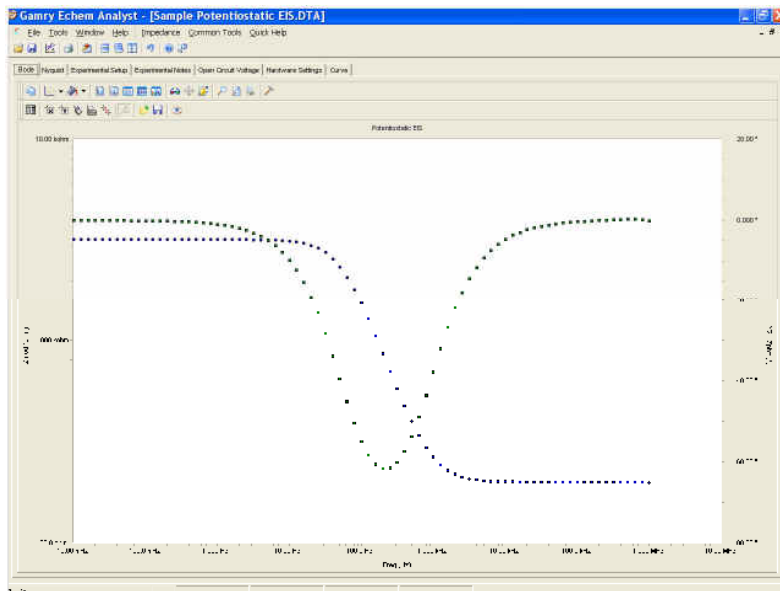

Bode plot

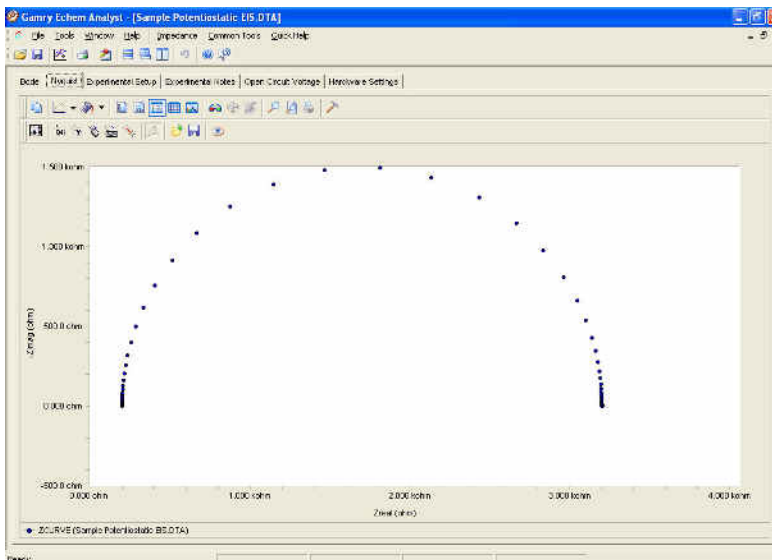

Nyquist plot



## EIS Special Tools

EIS data-analysis uses an equivalent-circuit approach. This menu creates and runs fits for EIS data. Commands in this menu allow you to build an equivalent-circuit model in the *Model Editor*, then fit that model to your data. This menu also lets you run advanced procedures, such as *Subtract Impedance*, and run Kramers-Kronig transforms.

1. In the main menu, choose *Impedance*.  
A drop-down menu appears.

2. To create or edit an equivalent circuit, choose *Model Editor*.  
The **Impedance Model Editor**

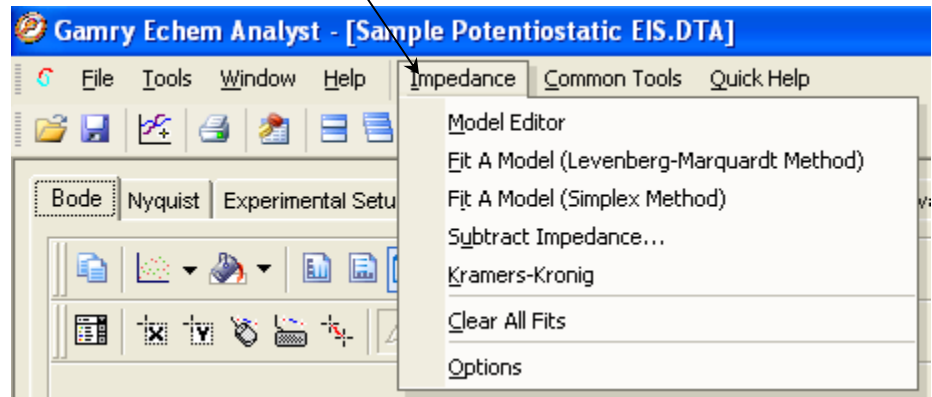

3. To fit the data using the Levenberg-Marquardt method, choose *Fit A Model (Levenberg-Marquardt Method)*.  
The **Select Model File** window opens.  
Choose the appropriate model file, and click the *OK* button.
4. To fit the data using the Simplex method, choose *Fit A Model (Simplex Method)*.  
Simplex method weighs the user's seed values less. We recommend using the Simplex method.
5. To subtract an impedance from the data, choose *Subtract Impedance...*  
The **Impedance Subtraction** window appears.  
Choose:  
Element Choose a circuit element from the drop-down menu.  
Model Browse for a previously defined model.  
Spectrum Browse for a data-set.  
Click the *Close* button.
6. To use the Kramers-Kronig method,  
Choose Kramers-Kronig.  
Kramers-Kronig is a model-independent transform that checks the EIS data for consistency.  
The **Kramers-Kronig** window appears.
7. To clear all fits from the plot,  
Choose *Clear All Fits*.
8. To change time or impedance units,  
Choose *Options*.  
This option let you normalize the data and fits to the normalized area.



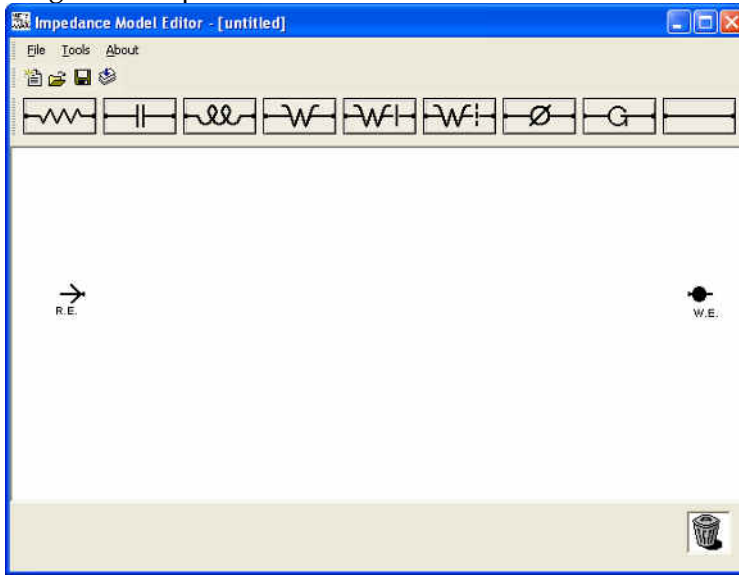

## The Model Editor

The **Impedance Model Editor** allows you to create an equivalent circuit, via a drag-and-drop method.

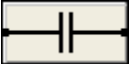

**→ DON'T FORGET!** There are several pre-loaded models. Often users find it convenient to start with one of these models and edit it as needed.

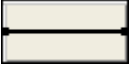
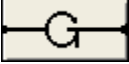
### Circuit Elements

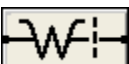
Symbol	Element	Comments
	Resistor	Abbreviated as R. $Z = R$
	Capacitor	Abbreviated as C. $Z = -i/\omega C$
	Inductor	Abbreviated as L. $Z = iL\omega$
	Constant Phase Element	Models an inhomogeneous property of the system, or a property with a distribution of values. Often abbreviated as CPE.
	Wire	Connects one element to the next.
	Gerischer element	Models a reaction in the surrounding solution that happened already; also used for modeling a porous electrode. Often abbreviated as G.
	Infinite Warburg	Models a linear diffusion to an infinite planar electrode. Often abbreviated as W.
	Bounded Warburg	Models diffusion within a thin layer of electrolyte, such as electrolyte trapped between a flat electrode and a glass microscope slide. Often abbreviated as T.
	Porous Bounded Warburg	Models diffusion through a thin layer of electrolyte, such as electrolyte trapped between an electrode and a permeable membrane covering it. Often abbreviated as O.

## Building an Equivalent Circuit

### 1. Adding an element

- a. Click on an element symbol.

The element appears in the central window.

- b. Place the mouse cursor over the element. Left-click and drag to move the element to its desired position.

### 2. Connecting elements

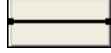
- a. Click on the *Wire* symbol .
- b. Left-click one end of the wire and drag the end to the element.

The element's border turns green when the wire's end reaches the element.

### 3. Deleting an element

- a. Right-click on the element.

The *Delete* command  appears.

- b. Left-click on the *Delete* command.

The element vanishes.

Here is an example of a simple equivalent circuit (a Randles model) constructed

### Model Editor:

### 4. Relabeling and fixing parameters for an element

This lets you rename the element, and specify a Lower and Upper Limit for its value. Renaming the element helps you distinguish between elements of the same type during fitting. Giving the program limits on the parameters may help the mathematical algorithm. For example, we know values are generally positive, so a Lower Limit = 0 is reasonable to set.

- a. Left-click on the name of the element (here, R4).

The **Parameter** window appears.

- b. Enter a new *Parameter Name*.
- c. Enter an *Initial Value*, i.e., the first trial value for fitting.
- d. In the *Lower Limit Test* and *Upper Limit Test* fields, enter lower and upper limits, and check the *Enable* checkbox, as desired.

- e. Click the *OK* button.

The **Parameter** window closes, and the element is set to these parameters.

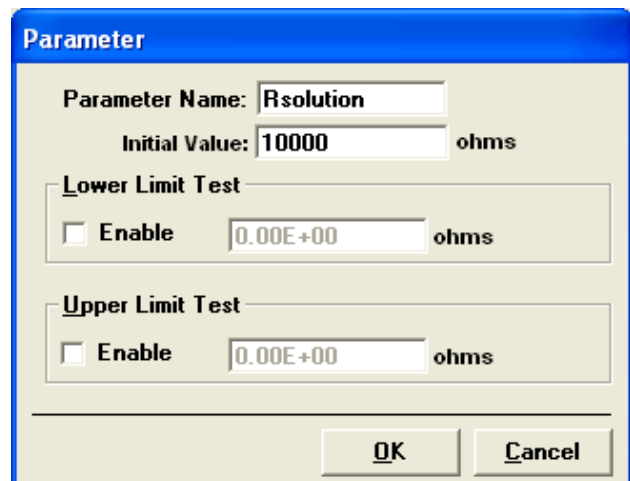
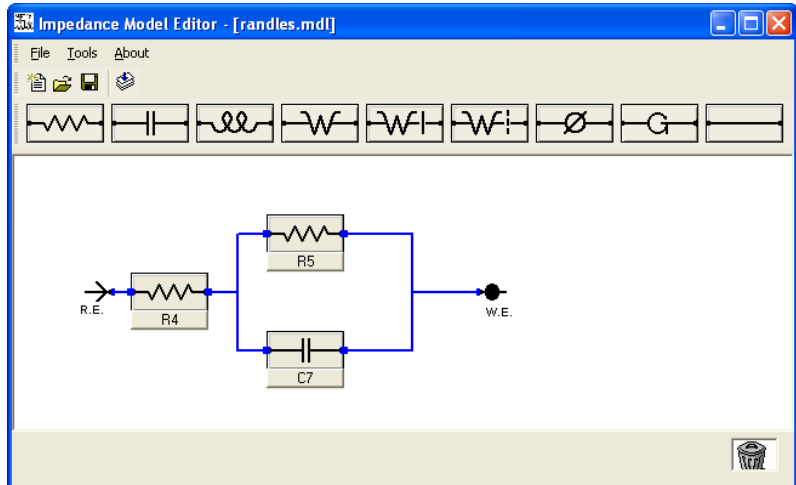
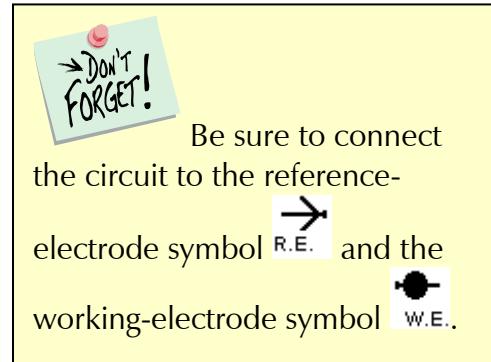

## Compiling the Equivalent Circuit

When the equivalent circuit is complete, the circuit can be compiled before use to check for connectivity of the wires. Compiling is only used to check connections

1. In the toolbar, choose *Tools*.  
A drop-down menu appears.

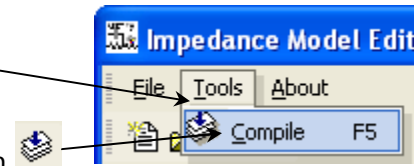

2. Choose *Compile* or click the *Test Compile* button in the toolbar.

The software compiles the equivalent circuit.

If there is a problem, such as a missing connection, an error message appears, and a red box outlines the problem element:



3. Click the *OK* button to continue.
4. Inspect the schematic and make necessary corrections.

If the equivalent circuit compiles properly, the **Model Editor** window appears:

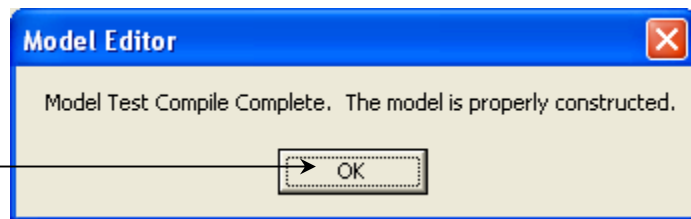

5. Click the *OK* button to continue.
6. You may save the equivalent circuit with a *\*.mdl* extension by clicking *File* in the toolbar, and choosing *Save* or *Save As*.

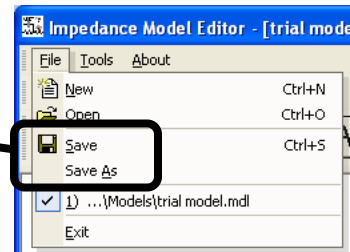

7. The **File Save As** window appears.  
The default folder for saving model equivalent circuits is the *Models* folder.

8. Name and save the file here, or choose a different folder.  
The model shown above was saved as `trial model.mdl`.  
The **File Save As** window closes.

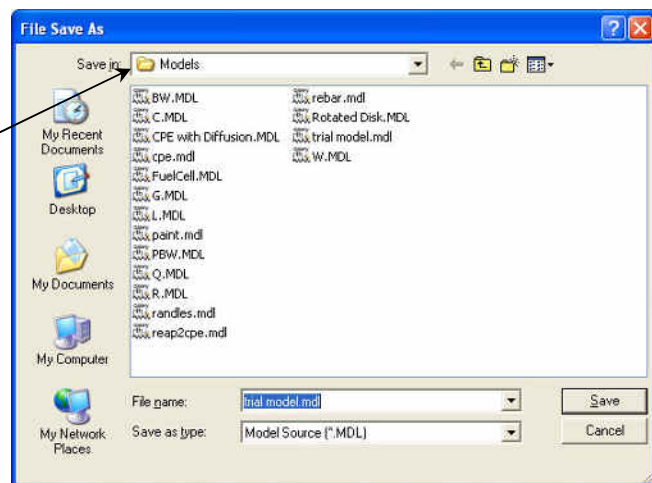



# Fitting the Data to the Equivalent-Circuit Model

1. With the data open and plotted, click *Impedance*, and choose *Fit A Model (Simplex Method)*.

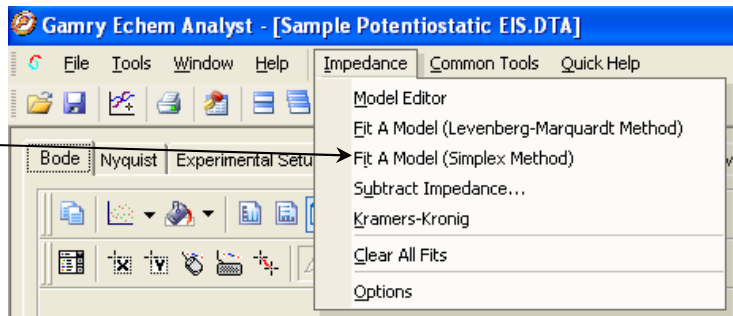

The **Select Model File** window appears.

2. Choose the desired model.

The default folder for models is the *Models* folder. This *Models* folder is in the C:\Documents and Settings\All Users\Application Data\Gamry Instruments\Echem Analyst\Models by default. As our example, we choose the model *trial model.mdl* created previously.

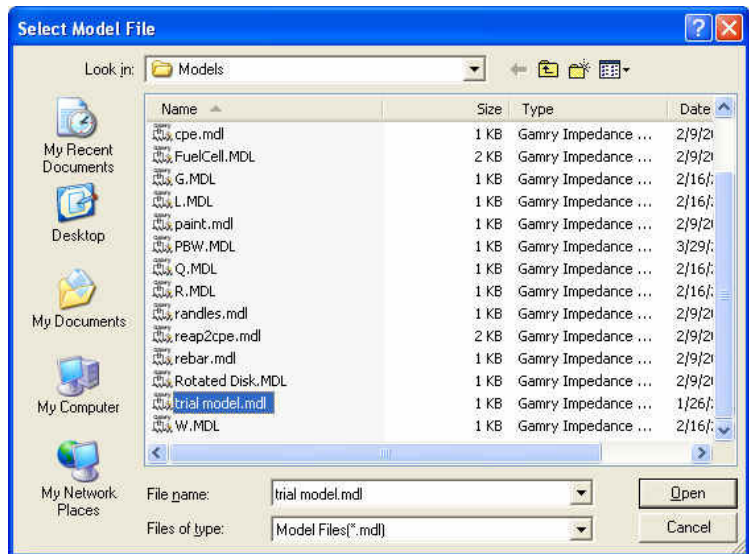

3. Click the *Open* button.

The **Select Model File** window closes, and the **Impedance Fit by the Simplex Method** window appears.

4. Set parameters.

Choose the maximum number of *Iterations* to loop before stopping the fit. Enter estimates for all the circuit elements in the *Model Parameters* area. Fix particular elements by enabling their *Lock* checkboxes.

In our example, we try 100  $\Omega$  for  $R_u$ , 2500  $\Omega$  for  $R_p$ , and 100 nF for  $C_f$  and leave all of them free (unlocked).

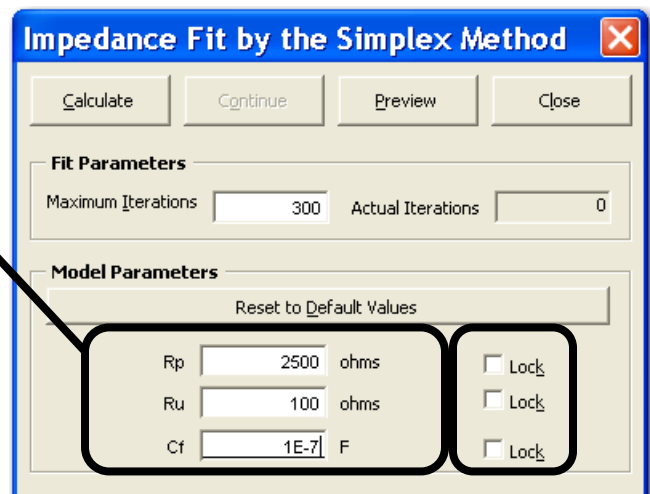

5. Click the *Calculate* button to start the fit.

The software attempts to fit the model to the data. When finished, the fitted parameters appear next to each circuit element.

Our model results give  
 $R_p = 3 \text{ k}\Omega$   
 $R_{\text{solution}} = 199.7 \text{ }\Omega$   
 $C_f = 980 \text{ nF}$

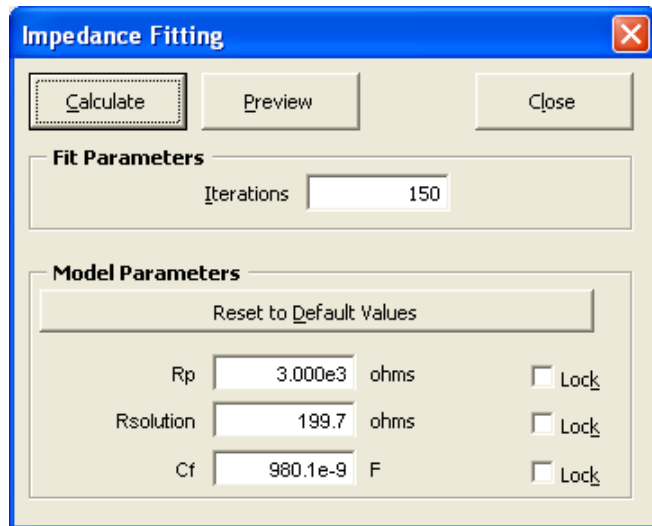

Like other Echem Analyst fits, the fit also appears superimposed upon the data and a new tab is created that contains those results.

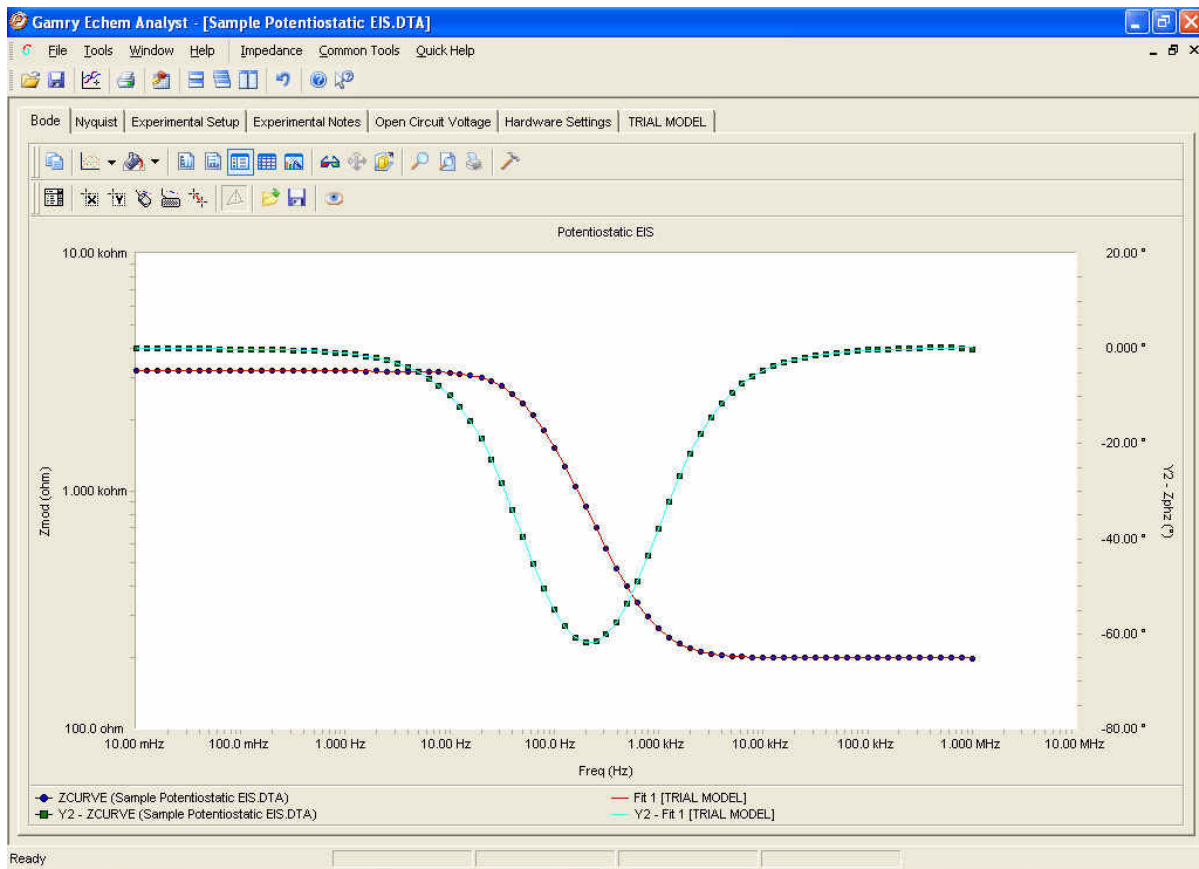

If you try another fit using the same model, this fit will be overwritten. If you fit to another model, the fit results of both models will be displayed.

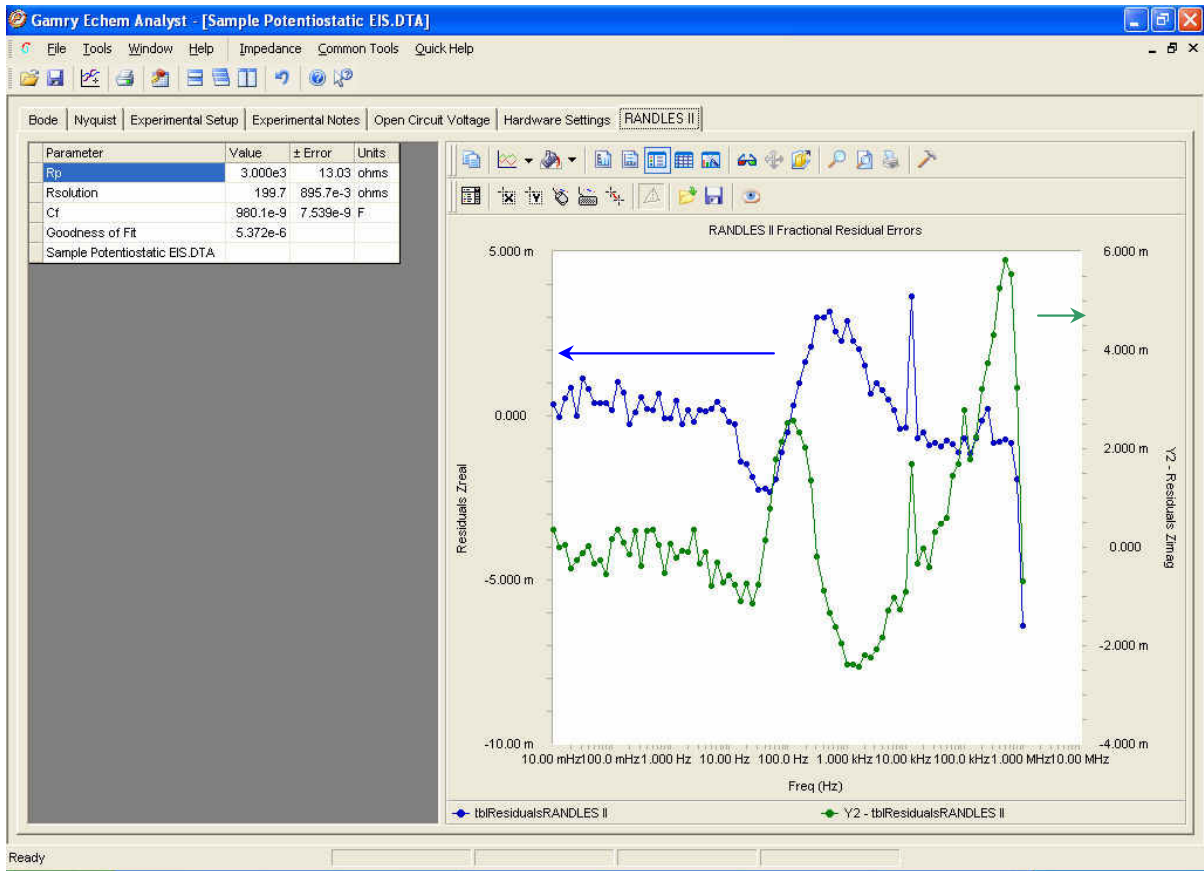

This new tab shows the residual errors and goodness of fit, along with the various plotting tools. Residuals are a point-by-point *Goodness of Fit*, which quantifies how closely the data match the fit. A smaller number indicates a better fit.

The blue data (*Zreal*) correspond to the y1-axis (on the left); the green data (*Zimag*) correspond to the y2-axis (on the right).

## Headings in Data-File Columns

### *DC Data Files*

<i>Abbreviation</i>	<i>Meaning</i>
Pt	Point number
T	Time
Vm, Vf	Measured voltage
Im	Measured current
Vu	Uncompensated voltage
Sig	Signal from the signal generator
Ach	Auxiliary channel
IE Range	I/E (Current Measurement) range on which measurement was made
Over	Any overloads. Numeric record of different overload types
0	No overloads

### *EIS Data Files*

<i>Abbreviation</i>	<i>Meaning</i>
Freq	Frequency
Zreal, Zimag, Zmod, Zphz	Calculated values of impedance
Idc, Vdc	DC component of current and voltage,
Yreal, Yimag	Admittance (calculated from Z)

# Current Conventions According to Framework™ and Echem Analyst

The current convention in the Framework for all experimental packages is that an anodic/oxidation current is positive.

To change the current convention (whether anodic/oxidation currents or cathodic/reduction currents are positive), in the menu *Tools\Options\Units* tab, specify the current you want represented as positive. The current convention can be changed by editing the experimental script (contact Gamry or your Gamry representative if you need to do this). Regardless of the current convention used in the Framework, it can be changed in the Echem Analyst to the one you desire by the user (see below for exceptions).



The current convention affects all experiments run under the PHE200 Physical Electrochemistry and PV220 Pulse Voltammetry heading. No other data files are affected.

To change the current convention in the Echem Analyst, in the menu *Tools/Options/Units* tab specify the current you want represented as positive.

To change the current convention in other experimental packages (DC105, EIS300 etc) please contact Gamry or your Gamry representative.

## To Edit Visual Basic Scripts:

1. In the toolbar, choose *Tools*.  
A dropdown menu appears.



Echem Analyst runs on “Open Source” scripts written in VBA. Most customized analysis routines are done by Gamry in the factory for you, the user, and that makes Echem Analyst extremely flexible. The typical user will never need to edit the scripts for electrochemical analysis.

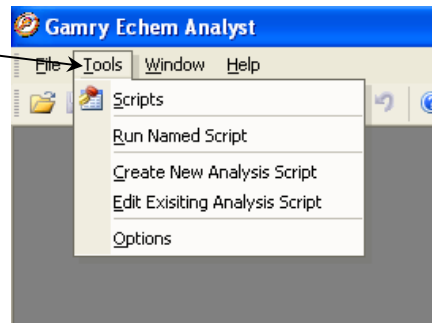

# Simulating an EIS Curve

It is often useful to simulate the response of an equivalent circuit.

1. Launch the Echem Analyst.
2. Select *Tools/Run Named Script/select EIS Model Simulation Script.Gscript*.

This opens a blank chart.

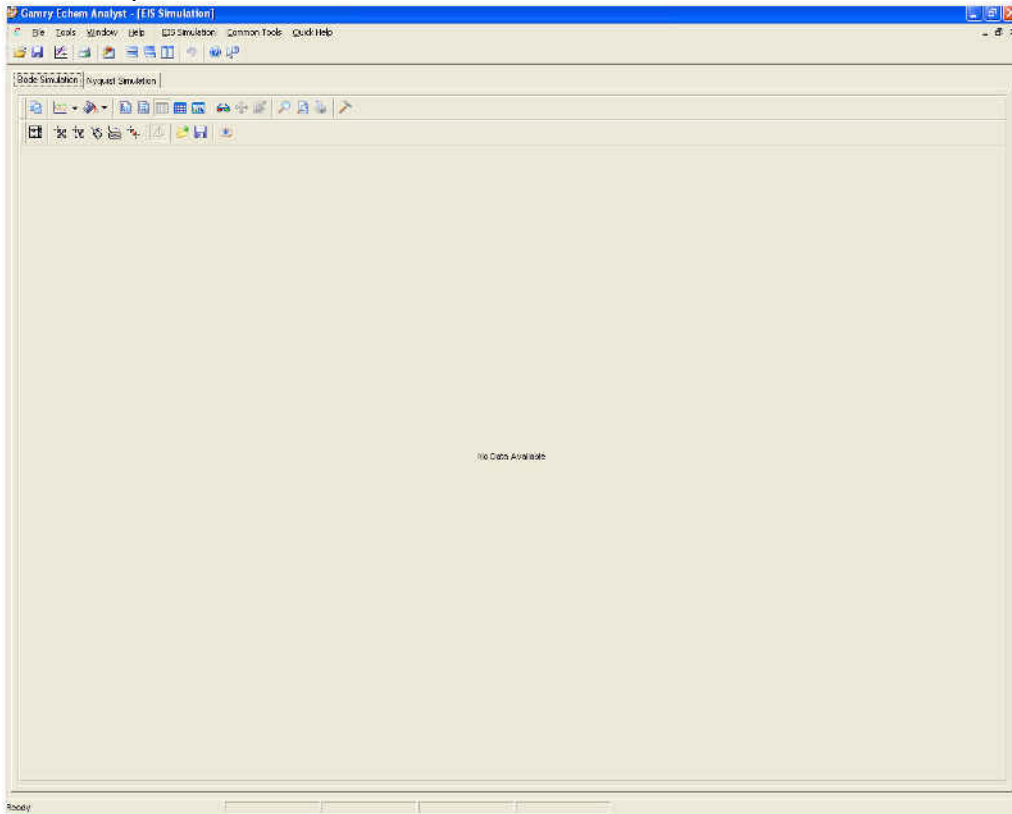

3. Select *EIS Simulation/Simulate* (use the *Model Editor* to build or edit the model).  
The **EIS Model Simulation** window appears.

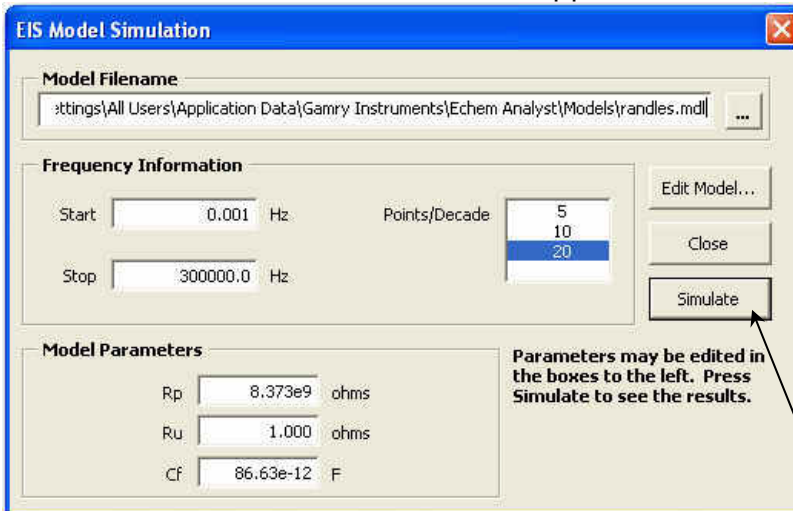

4. Select the saved model, and input parameters for the experiment (frequencies and data-point density) and values of all circuit elements.
5. Click the *Simulate* button.  
The simulation appears under new tabs.

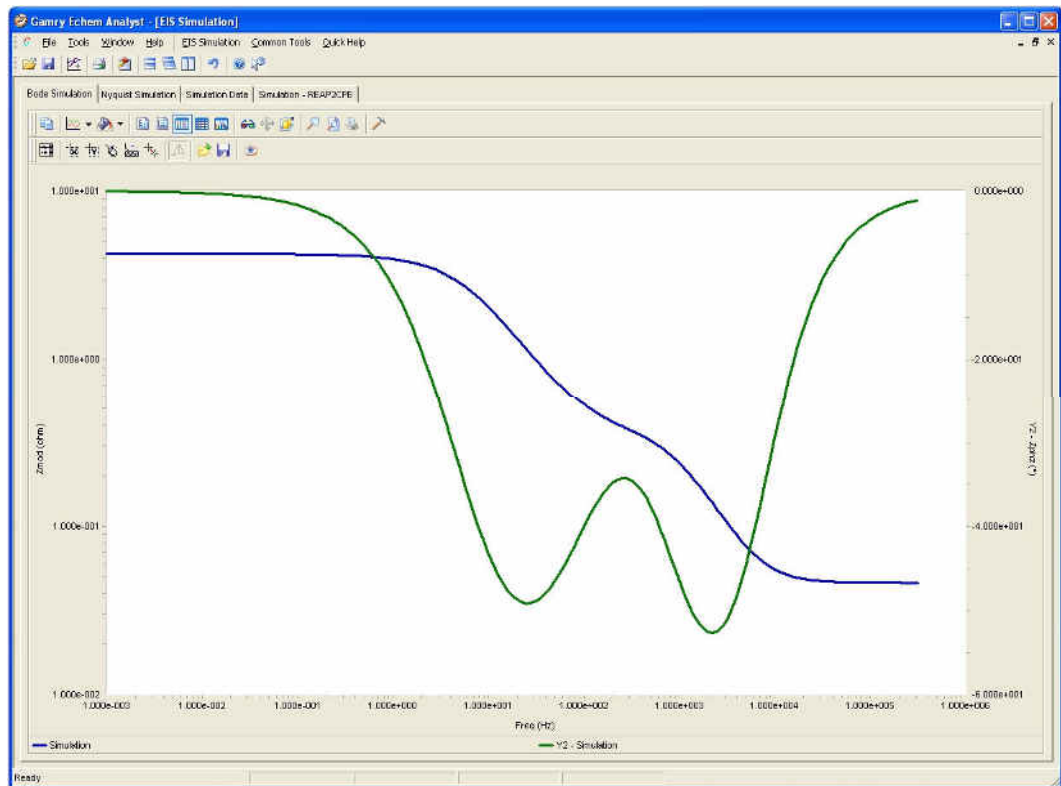

This is a simulated Bode plot.

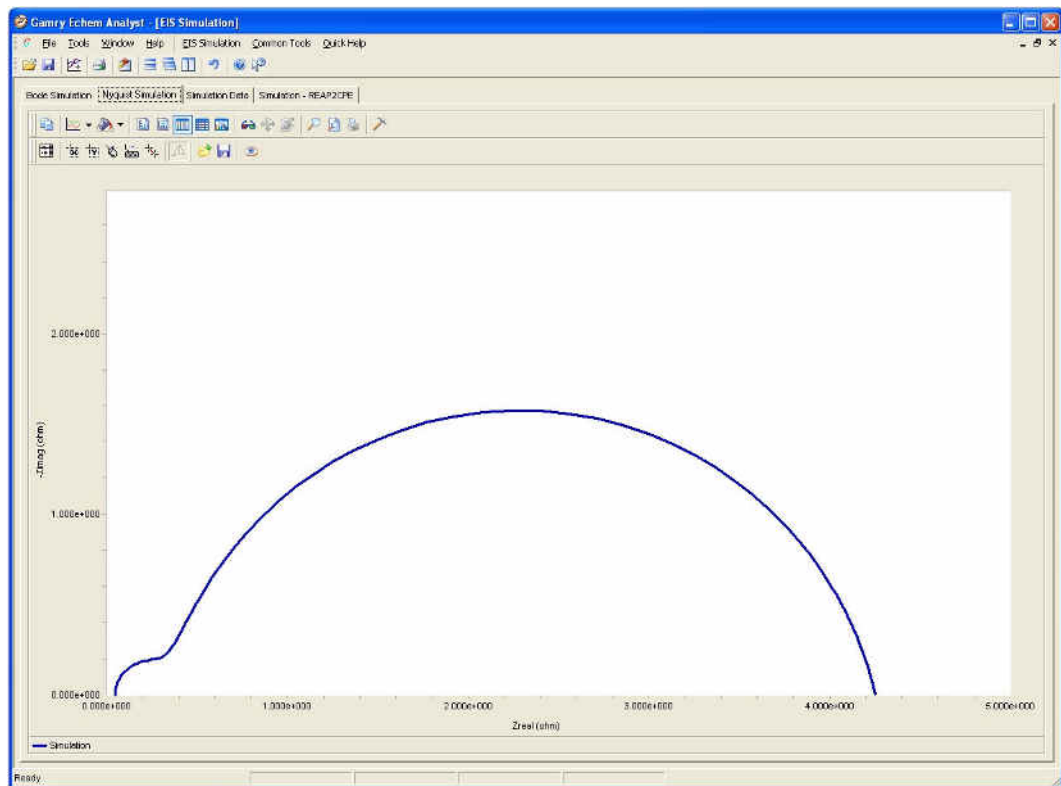

This is a simulated Nyquist plot.





<i>Goodness of Fit</i>	35	<b>Model Editor</b> window	32
		<i>Model Parameters</i> area	33
		<i>Models</i> folder	32, 33
		Mouse button	9
		<i>My Gamry Data</i> folder	3, 4
		<b>N</b>	
		Normalize by Scan Rate	21
		Normalize by Square Root of the Scan Rate	21
		<i>Notes...</i> field	16
		<i>Nyquist</i> tab	28
		<b>O</b>	
		OK button	29, 31, 32
		open	3
		<i>Open</i> button	33
		Open Circuit	15
		<i>Open Circuit Voltage</i> tab	4, 19
		<i>Open</i> function	3
		<i>Open With...</i>	10
		<i>Options</i>	4, 21, 24, 25, 29
		Origin®	3, 10
		Over	36
		<b>P</b>	
		<b>Page setup</b> window	6
		<i>Palette</i> button	6
		<i>PaletteBar</i>	6
		<i>Parameter Name</i>	31
		<b>Parameter</b> window	31
		<i>Path</i>	4
		Peak Baselines	21
		Peak Find	21
		<i>Peak Find</i> function	9
		plots	5
		<i>Polarization Resistance</i>	13, 14, 24, 25, 27
		<b>Polarization Resistance</b> window	24
		Porous Bounded Warburg	30
		Positive Feedback IR Comp	17
		Positive Feedback Resistance	18
		Post-Run iR Correction	14
		<i>Potentiodynamic</i>	26
		Potentiostat	17
		Powerpoint®	10
		Print	6
		Print preview	6
		Properties...	6
		Pstat Model	18
		Pt 36	
		<b>Q</b>	
		Quick Integrate	21, 22, 24
		<i>Quick-Integrate</i>	7
		<b>R</b>	
		Randles model	31
		<i>Region Baseline</i>	23
		<b>Region Baseline Settings</b> window	23
			41
<i>Hardware Settings</i> tab	4, 17, 27		
help	11		
<i>Help</i>	11		
Horizontal Grid	6		
		<b>H</b>	
		<b>I</b>	
I/E AutoRange	17		
I/E Range	18		
I/E Range Lower Limit	17		
I/E Range Mode	15		
I/E Stability	18		
Ich AutoRange	17		
Ich Filter	17		
Ich Offset	17		
Ich Offset Enable	17		
Ich Range	17		
Idc36			
IE Range	36		
Im 36			
<i>Impedance</i>	29		
<b>Impedance Fit by the Simplex Method</b> window	33		
<b>Impedance Model Editor</b>	29, 30, 31		
<b>Impedance Model Editor</b> window	29		
<b>Impedance Subtraction</b> window	29		
Inductor	30		
Infinite Warburg	30		
Init. Delay	15		
Initial Delay	4, 15		
Initial E	15		
<i>Initial Value</i>	31		
Installation	3		
Instrument Version	18		
Integrate	21, 22, 23		
Integrating the voltammogram	22		
IR Comp	15		
<i>Iterations</i>	33		
		<b>K</b>	
Kramers-Kronig method	29		
Kramers-Kronig transforms	29		
<b>Kramers-Kronig</b> window	29		
		<b>L</b>	
Legend Bar	6		
Levenberg-Marquardt method	29		
<i>Linear Fit</i>	13, 14		
Lock checkbox	33		
<i>Lower Limit Test</i>	31		
		<b>M</b>	
Mark Found Peaks	7		
Max Current	15		
Min/Max	21, 24		
Model	29		
<i>Model Editor</i>	29, 30, 38		

Region Baselines	21, 23	<i>Transform Axes</i> selection	11
Resistor	30		
Rotate	6		
		<b>U</b>	
		<i>Units</i> tab	37
		<i>Upper Limit Test</i>	31
		<i>Use Seed Values</i> checkbox	26
		<b>V</b>	
		Vch AutoRange	18
		Vch Filter	18
		Vch Offset	18
		Vch Offset Enable	18
		Vch Range	18
		Vdc	36
		Vertical Grid	6
		Vf 36	
		<i>Visible Traces</i> area	8
		Visual Basic	37
		Vm	36
		Vu 36	
		<b>W</b>	
		website	3
		Wire	30, 31
		Word®	10
		<b>X</b>	
		X-Axis column	8
		<b>Y</b>	
		Y2-Axis column	8
		Y-Axis column	8
		Yimag	36
		Yreal	36
		<b>Z</b>	
		Z-clustered	6
		Zimag	35, 36
		Zmod	36
		Zoom	6
		Zphz	36
		Zreal	35, 36
<b>S</b>			
Sampling Mode	15		
Save	32		
Save As	32		
Save as Defaults	25		
Save Template	7		
<b>Save User-Defined Chart Template</b> window	7		
Scan Rate	15		
<i>Seed Values</i> area	24, 26		
<b>Select Model File</b> window	29, 33		
Select Portion of Curve using the Keyboard	7		
Select Portion of Curve using the Mouse	7		
Select x region	7		
Select y region	7		
Selecting portions of a curve	9		
<i>Selection toolbar</i>	9		
<i>Selection Toolbar</i>	5, 7		
Show curve selector	7		
Show Disabled Points	7		
Sig36			
Simplex method	29		
<i>Simulate</i> button	38		
<i>Simulating an EIS curve</i>	38		
<i>Smooth Data</i>	13, 14		
Spectrum	29		
Step Size	15		
Subtract Background from File	21		
<i>Subtract Impedance</i>	29		
<i>Subtract Impedance...</i>	29		
<b>T</b>			
T 36			
Tafel constants	24, 25		
<i>Tafel Fit</i>	9, 26		
<i>Tafel Fit</i> function	9		
<b>Tafel Fit</b> window	26		
<i>Tafel</i> tab	27		
<i>Test Compile</i> button	32		
Test Identifier	15		
Time	15		
toolbars	5		
Tools	6, 32		
<i>Tools.</i>	37		
Transform Axes	14		